

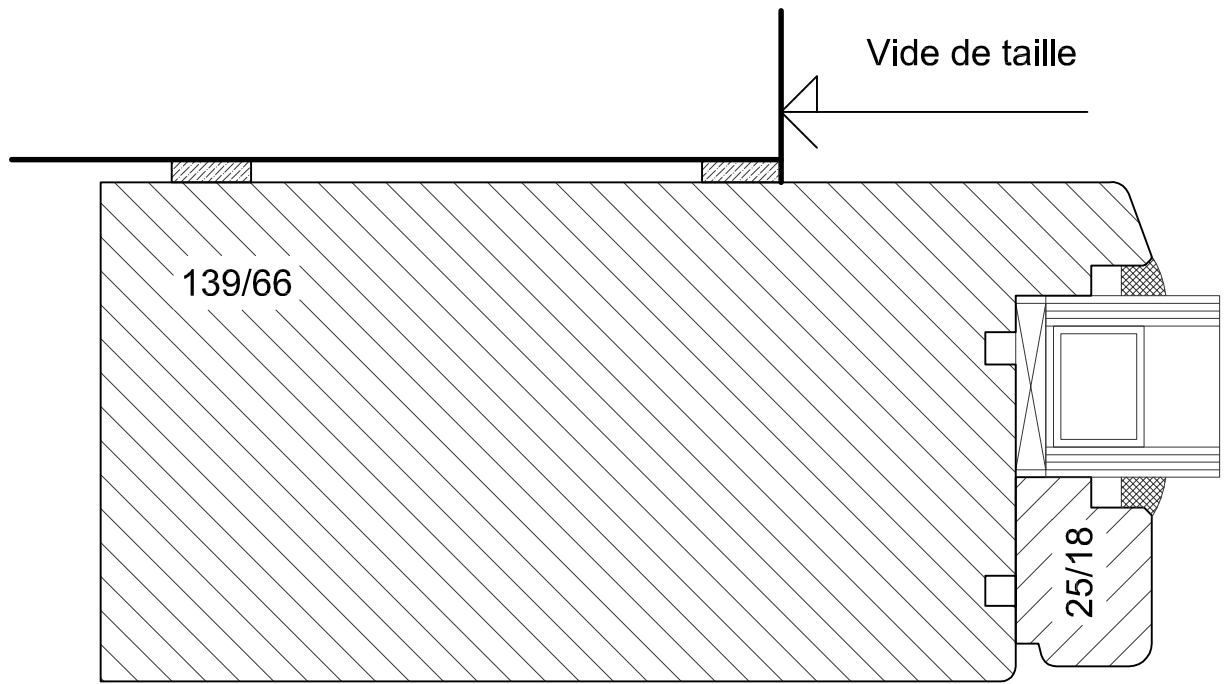

	Bois 66-78	Echelle 1 : 1
	Fixe dans le cadre	Date 14/02/2012
		B/66/100



	Bois 66-78	Echelle 1 : 1
	Baie-fixe	Date 14/02/2012
		B/66/101

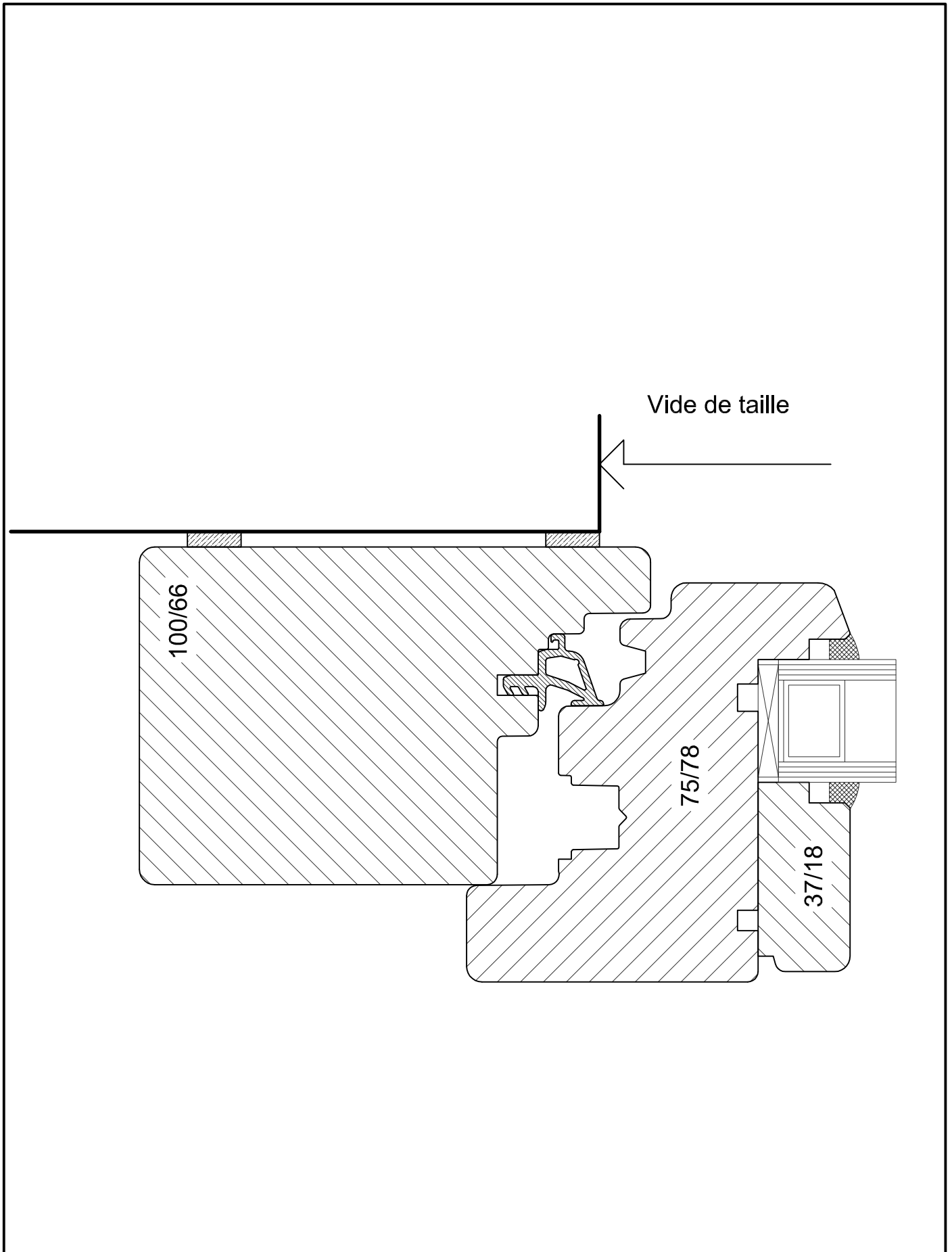

	Bois 66-78	Echelle 1 : 1
	Montant standard	Date 14/02/2012
		B/66/102

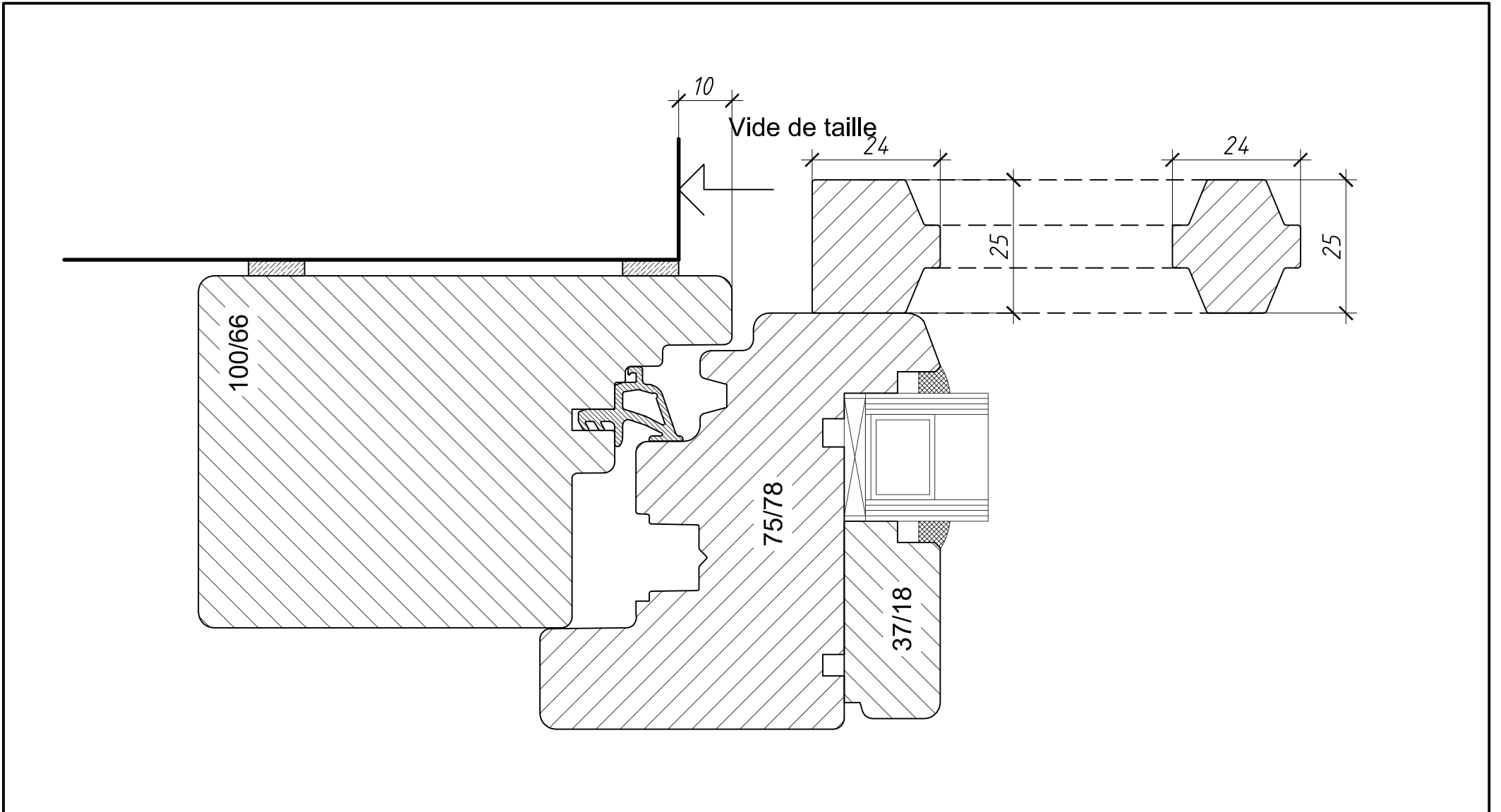

B/66/102a	Date 14/02/2012	Echelle 1 : 1
-----------	--------------------	------------------



Bois 66-78.dwg	Echelle 1 : 1
Montants avec chassis croisillons	Date 14/02/2012
	B/66/102a

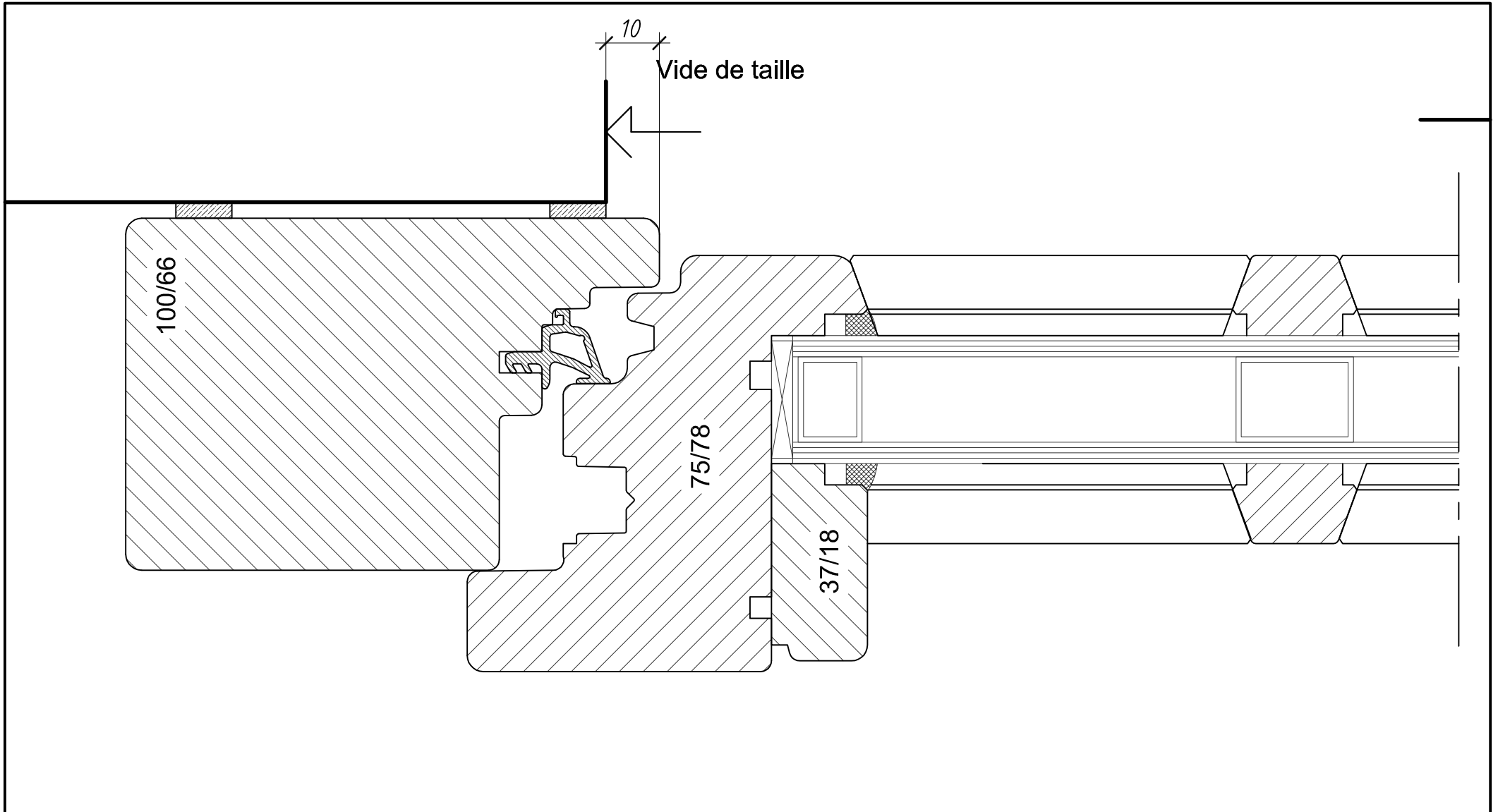

Echelle 1 : 1
Date 14/02/2012
B/66/102c



Bois 66-78.dwg	Echelle 1 : 1
Croisillons rapporté intérieurs et extérieurs sur vi double	Date 14/02/2012
	B/66/102c

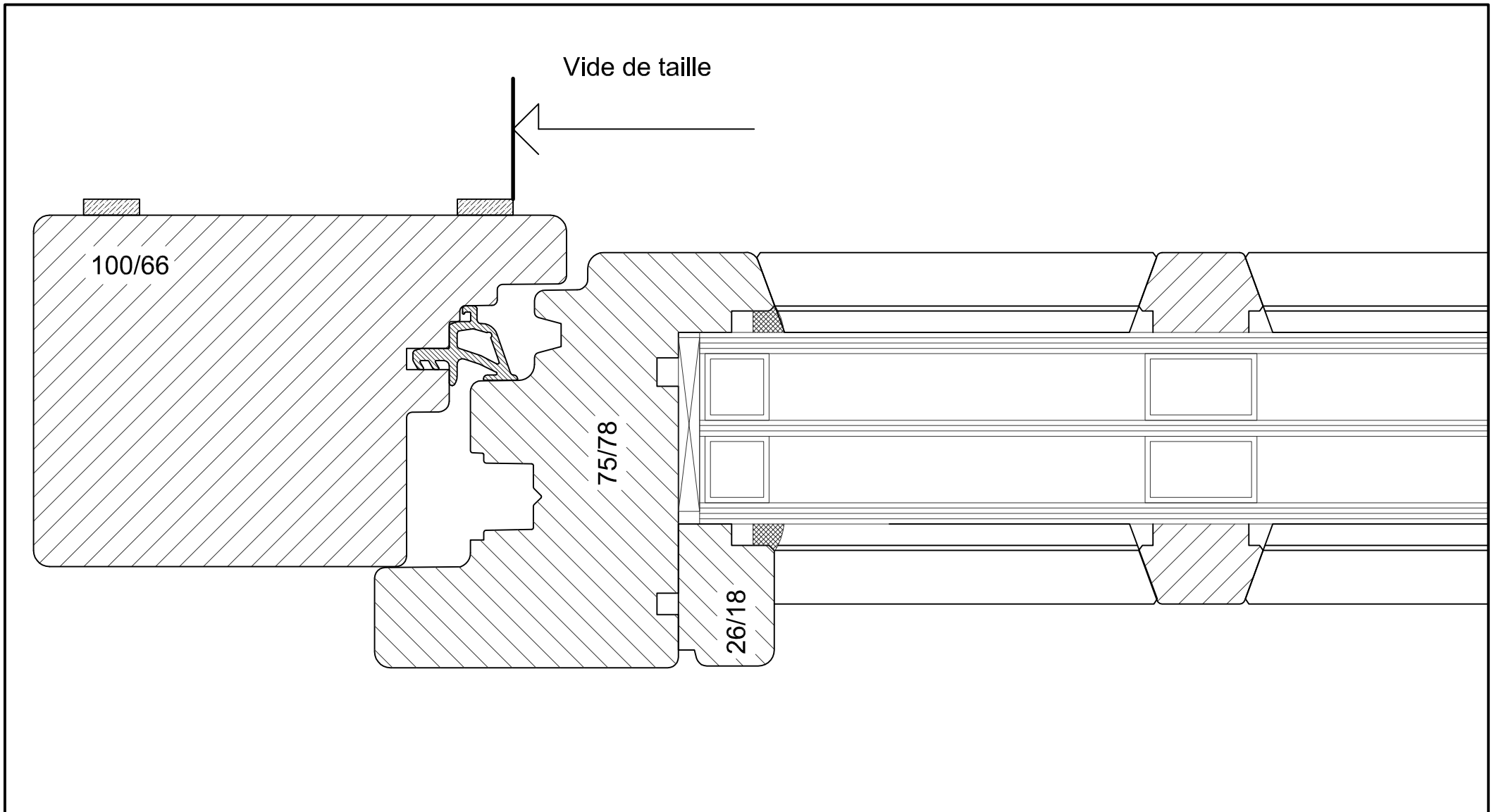

B/66/102c1	Date 14/02/2012	Echelle 1 : 1
------------	--------------------	------------------



Bois 66-78.dwg	Echelle 1 : 1
Croisillons rapporté intérieurs et extérieurs sur vi triple	Date 14/02/2012
	B/66/102c1

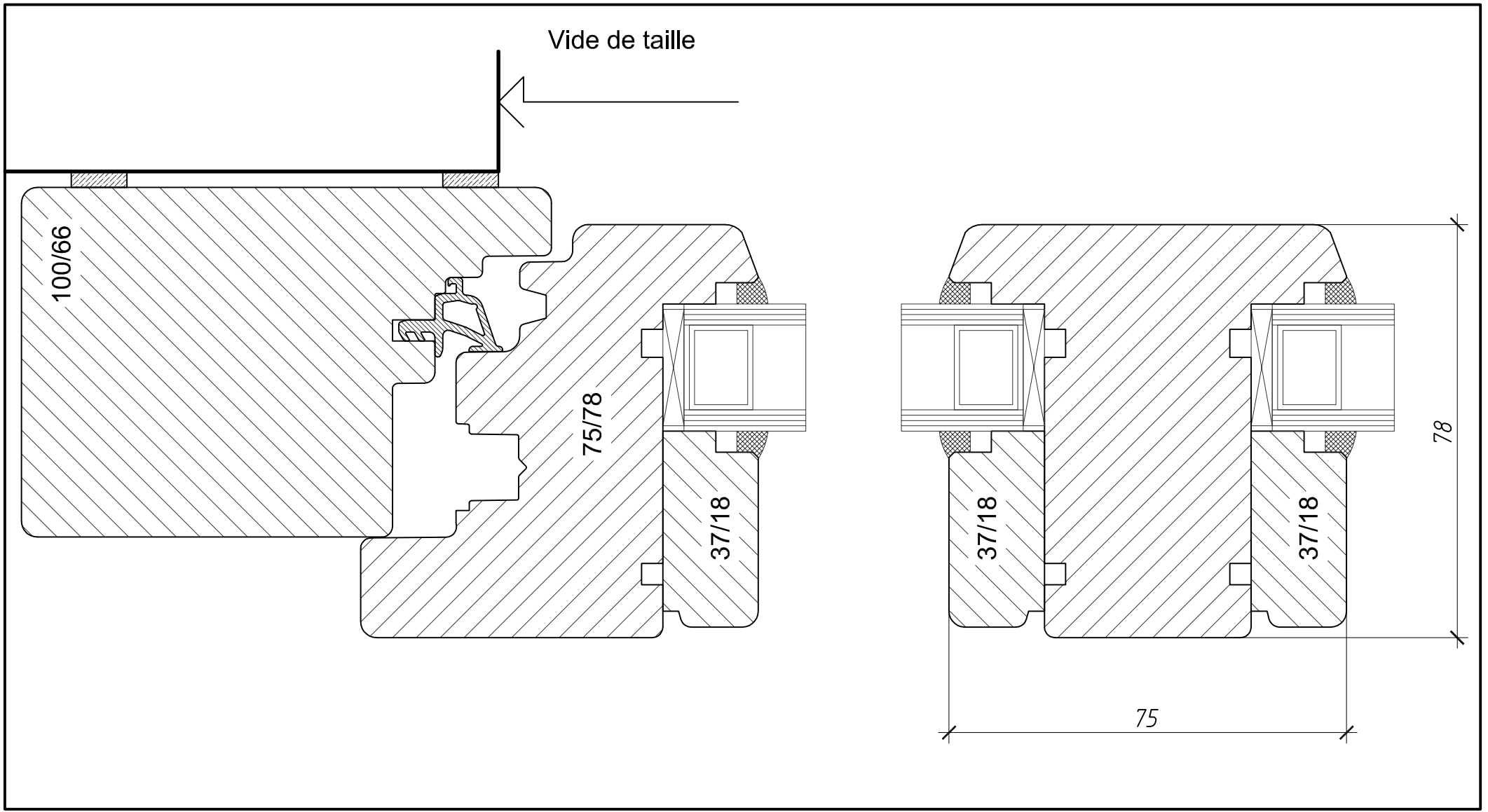

B/66/102d	Date 17/02/2012	Echelle 1 : 1
-----------	--------------------	------------------



Bois 2012 client.dwg	Echelle 1 : 1
Montants ou traverse intermédiaire guichet	Date 17/02/2012
	B/66/102d

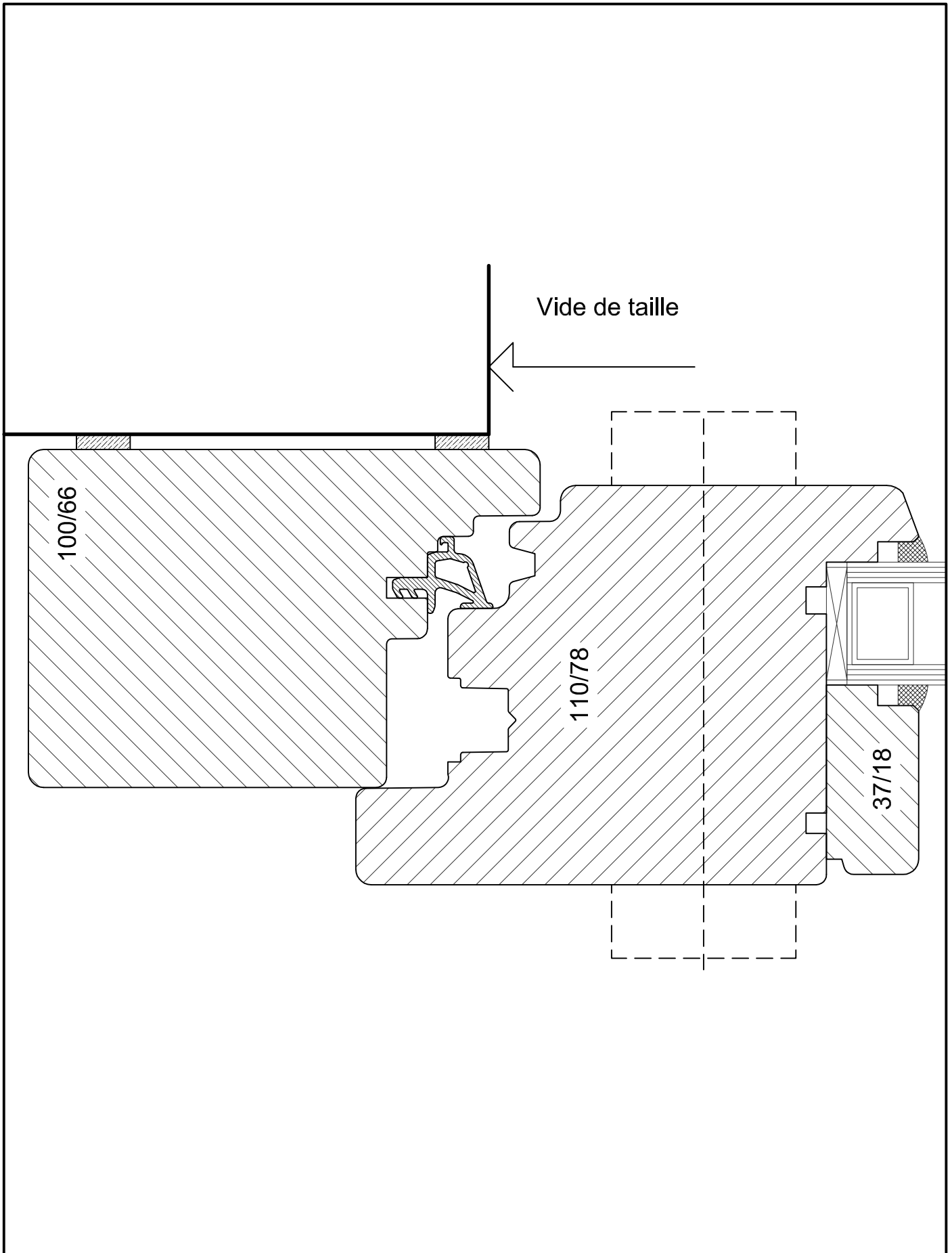

	Bois 2012 client	Echelle 1 : 1
	Montants Balcover poignée traversante	Date 17/02/2012
		B/66/103

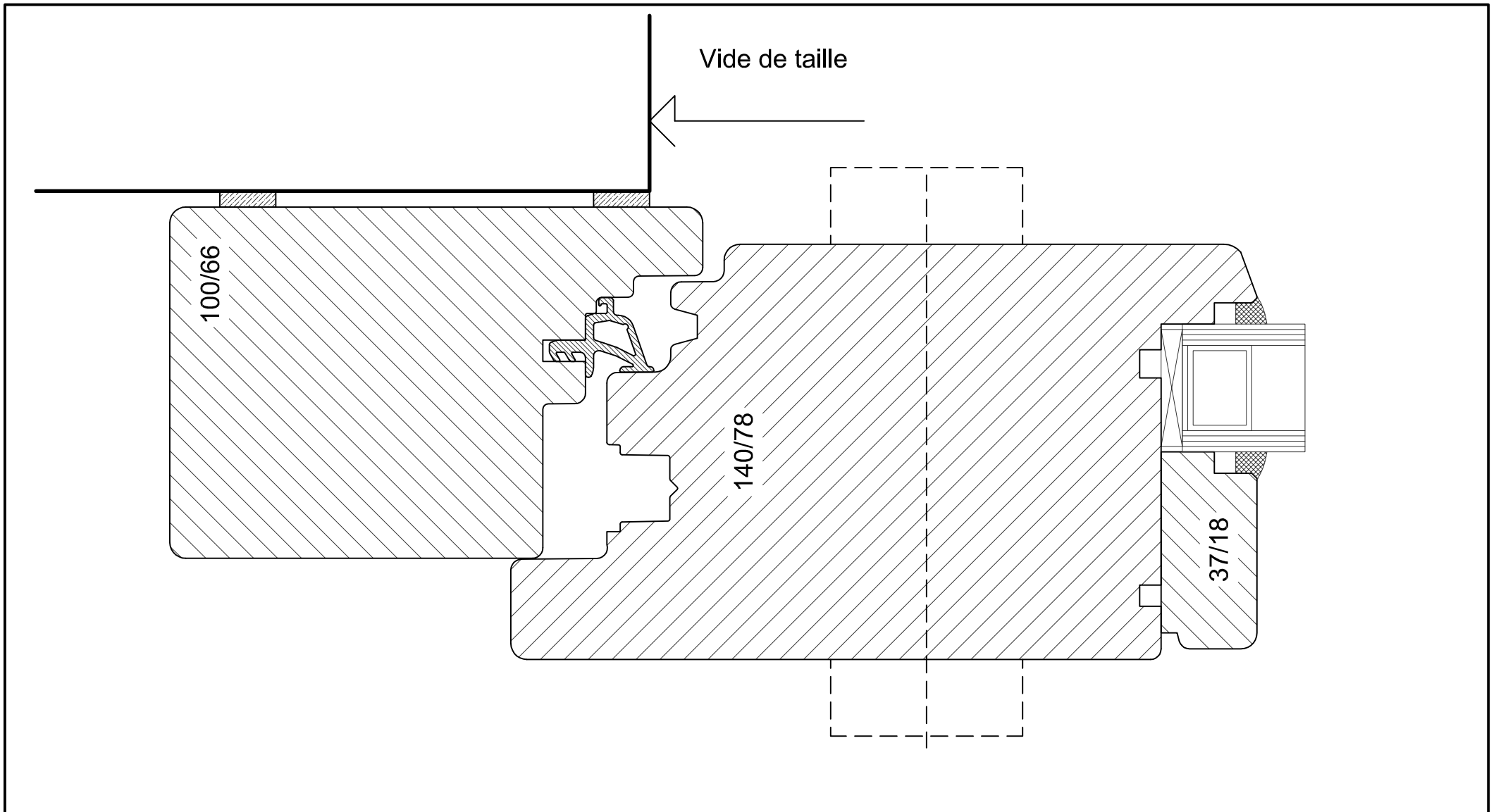

Echelle 1 : 1
Date 17/02/2012
B/66/104



Bois 2012 client.dwg	Echelle 1 : 1
Montants Porte entrée poignée traversante	Date 17/02/2012
	B/66/104

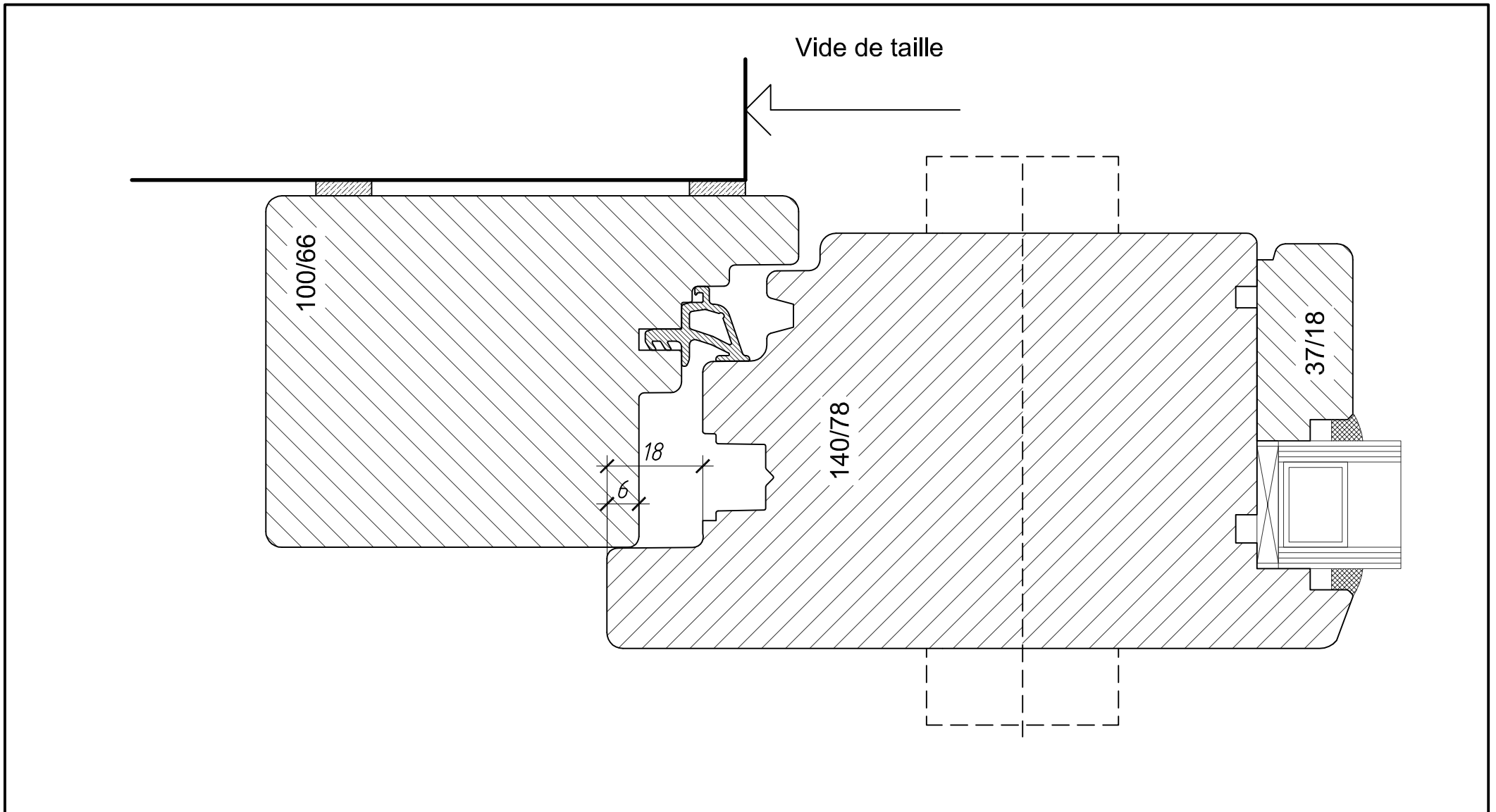



B/66/105	Date 17/02/2012	Echelle 1 : 1
----------	--------------------	------------------

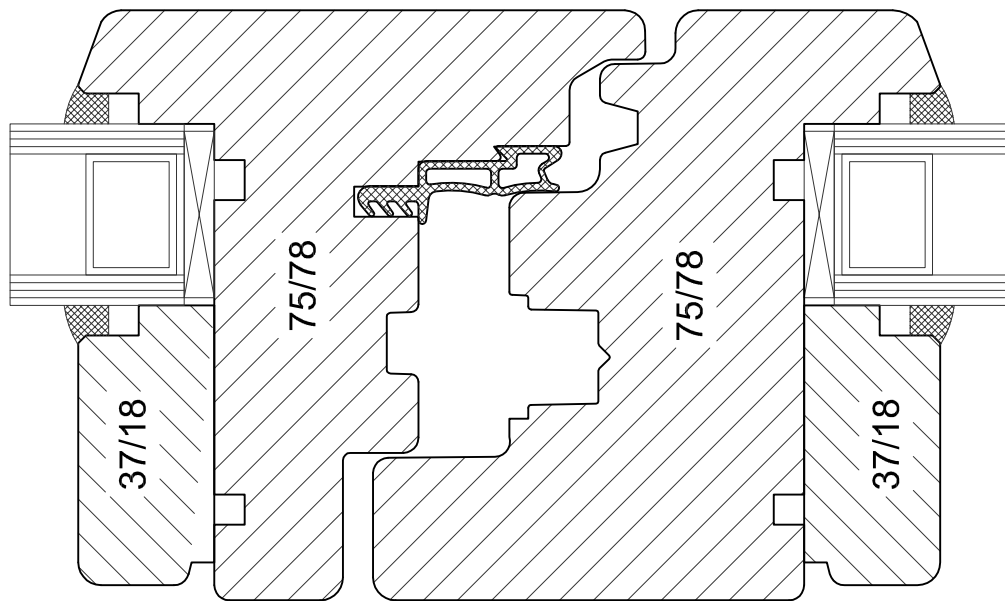

Bois 2012 client.dwg	Echelle 1 : 1
Montants Porte ouverture sur l'exétrieure	Date 17/02/2012
	B/66/105

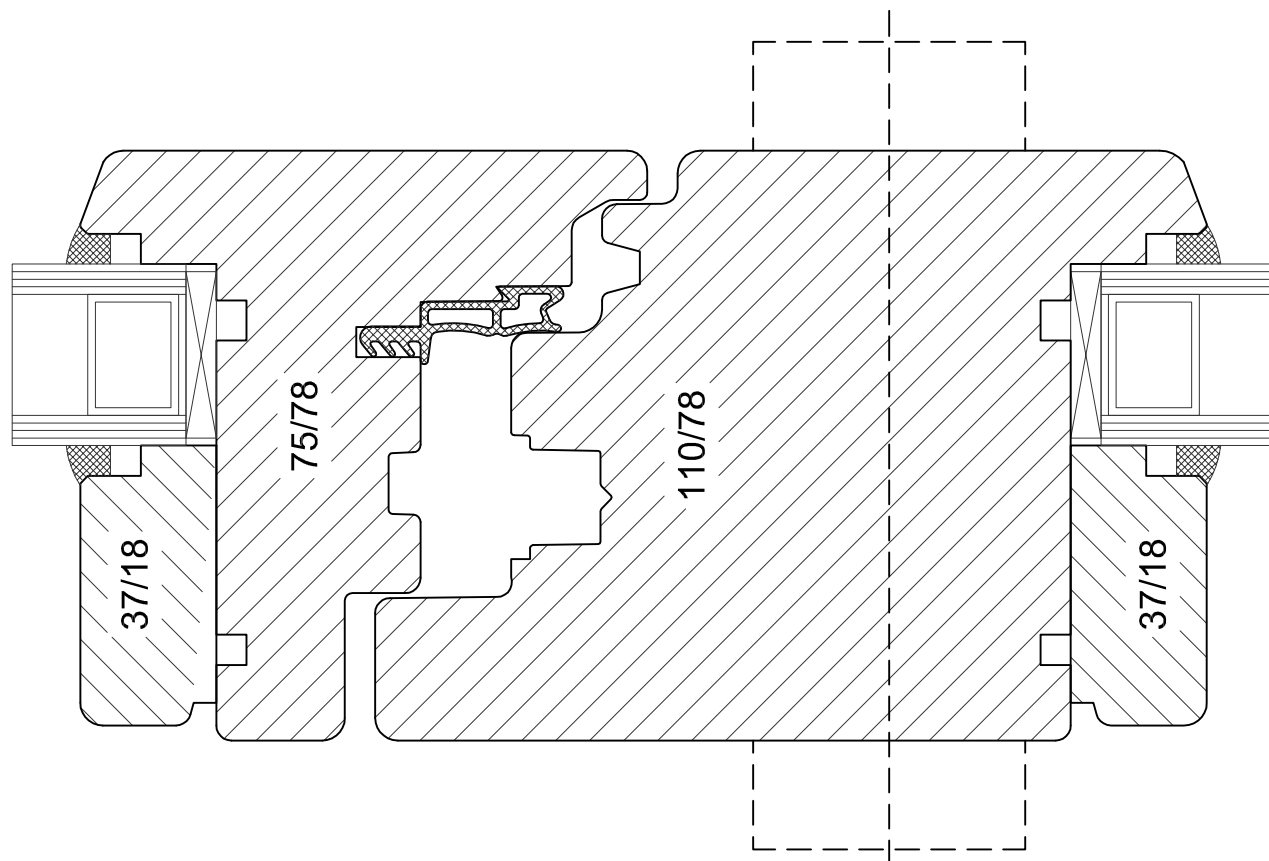



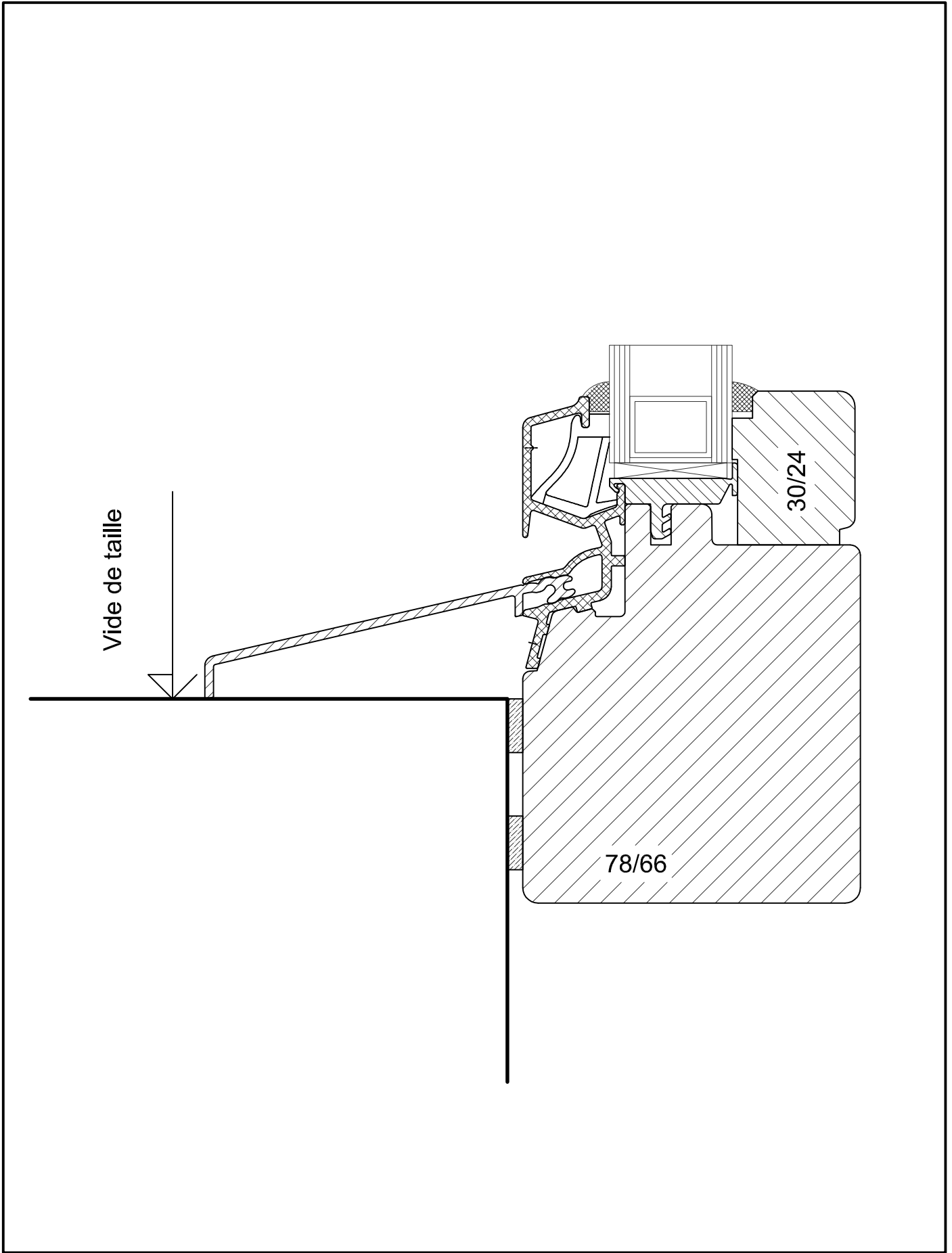

	Bois 2012 client	Echelle 1 : 1
	Montants central balcover	Date 17/02/2012
		B/66/201

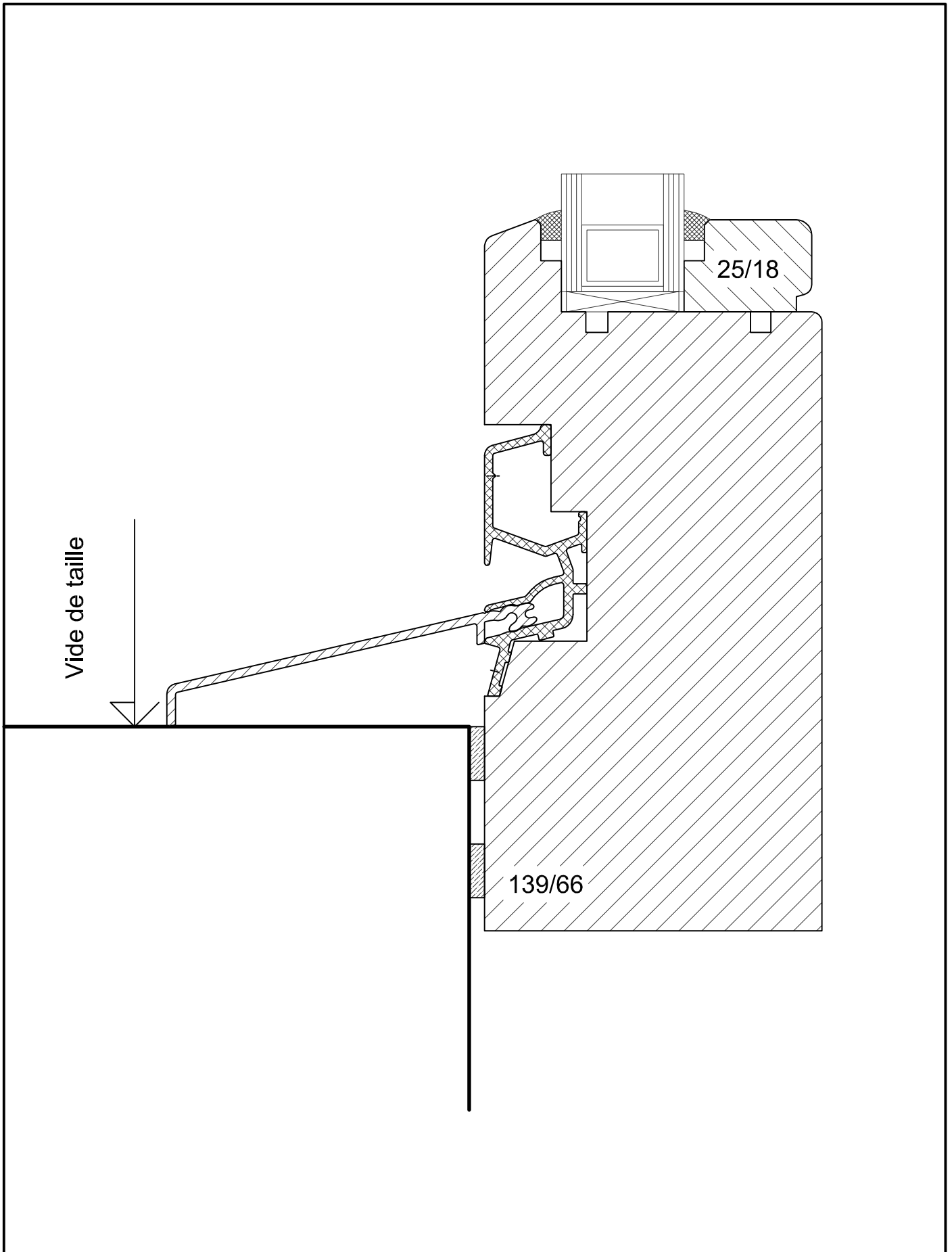

	Bois 2012 client	Echelle 1 : 1
	Fixe dans le cadre	Date 17/02/2012
		B/66/300



	Bois 2012 client	Echelle 1 : 1
	Baie-fixe	Date 17/02/2012
		B/66/301

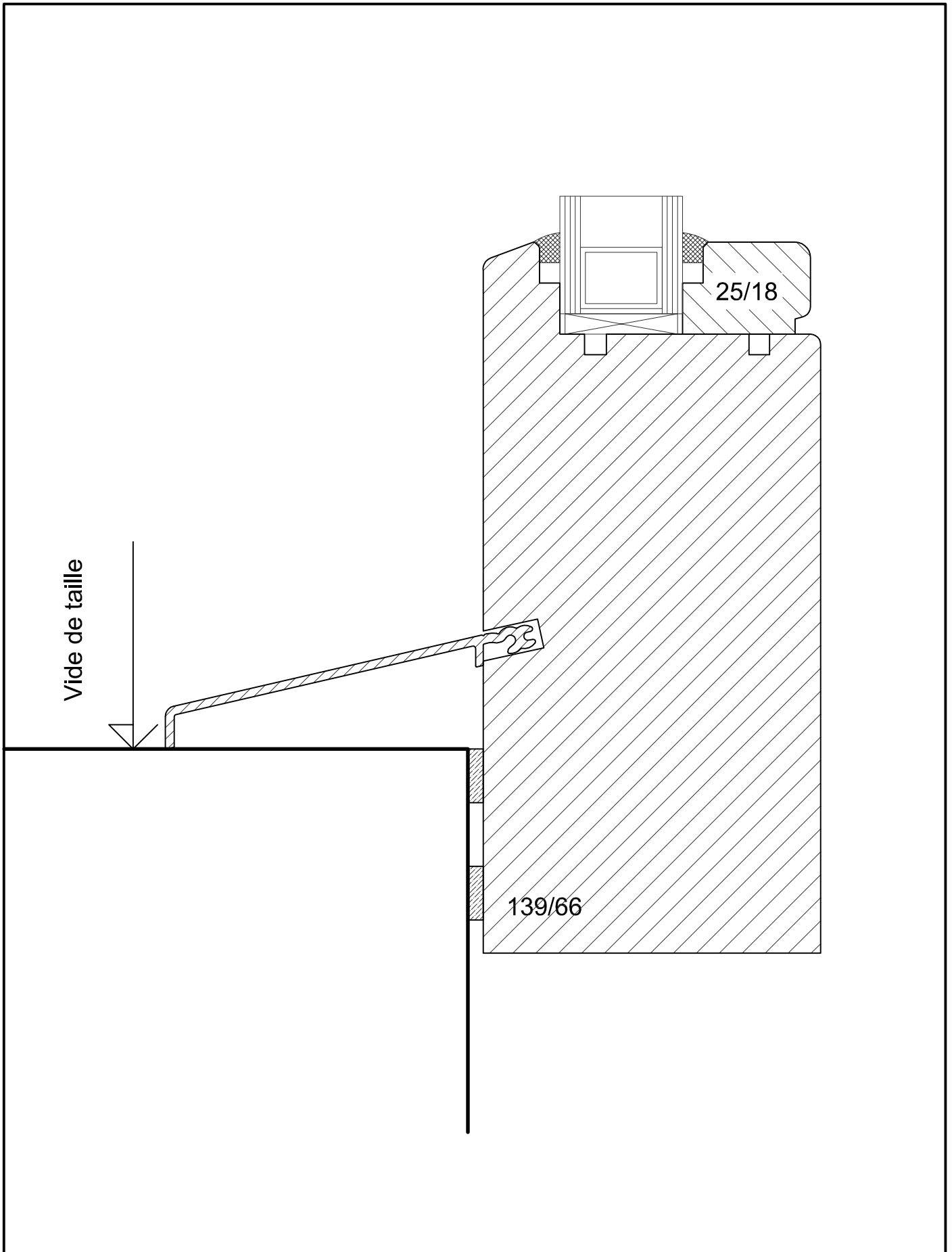

	Bois 2012 client	Echelle 1 : 1
	Baie-fixe	Date 17/02/2012
		B/66/301A

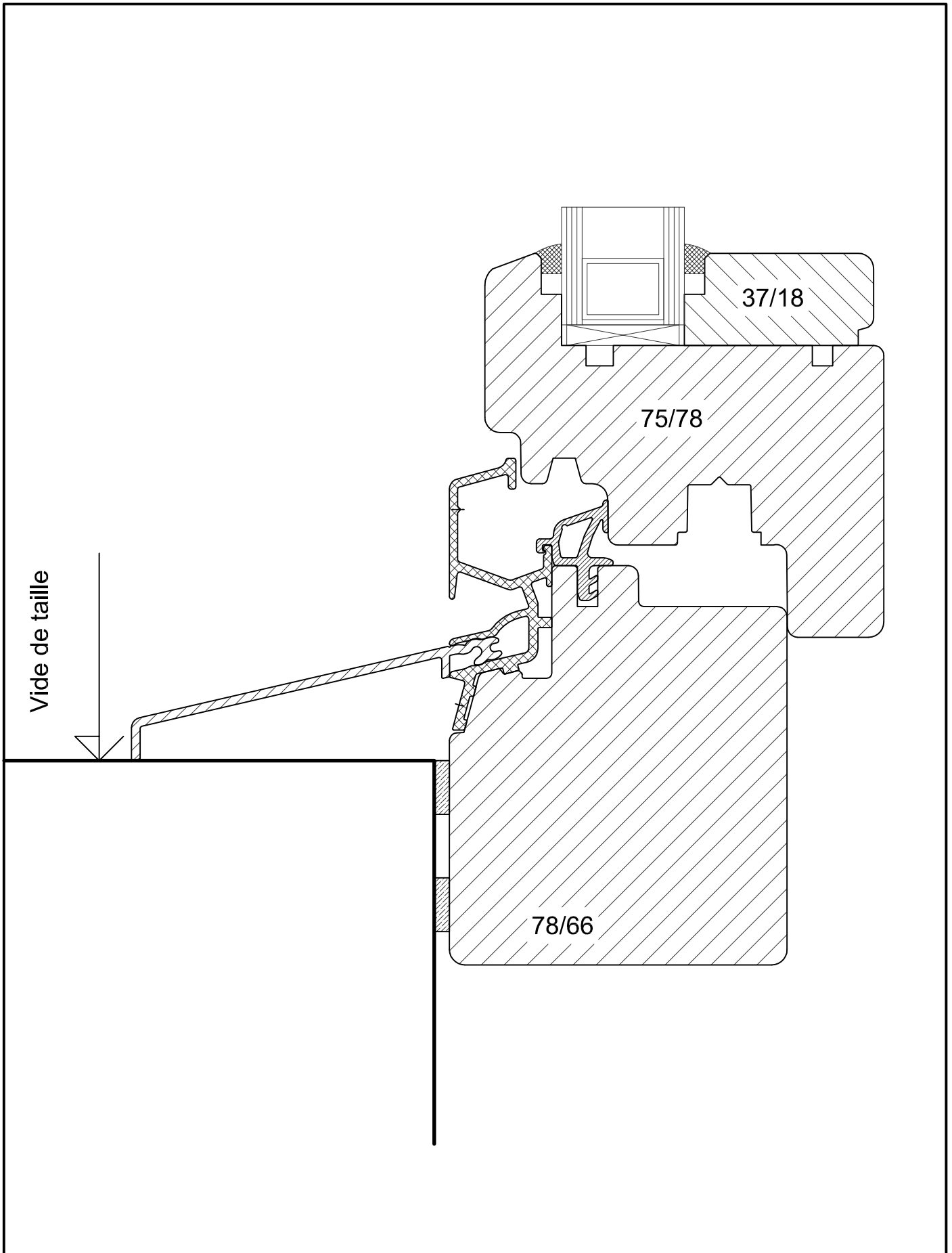

	Bois 2012 client	Echelle 1 : 1
	Traverse basse standard	Date 17/02/2012
		B/66/302

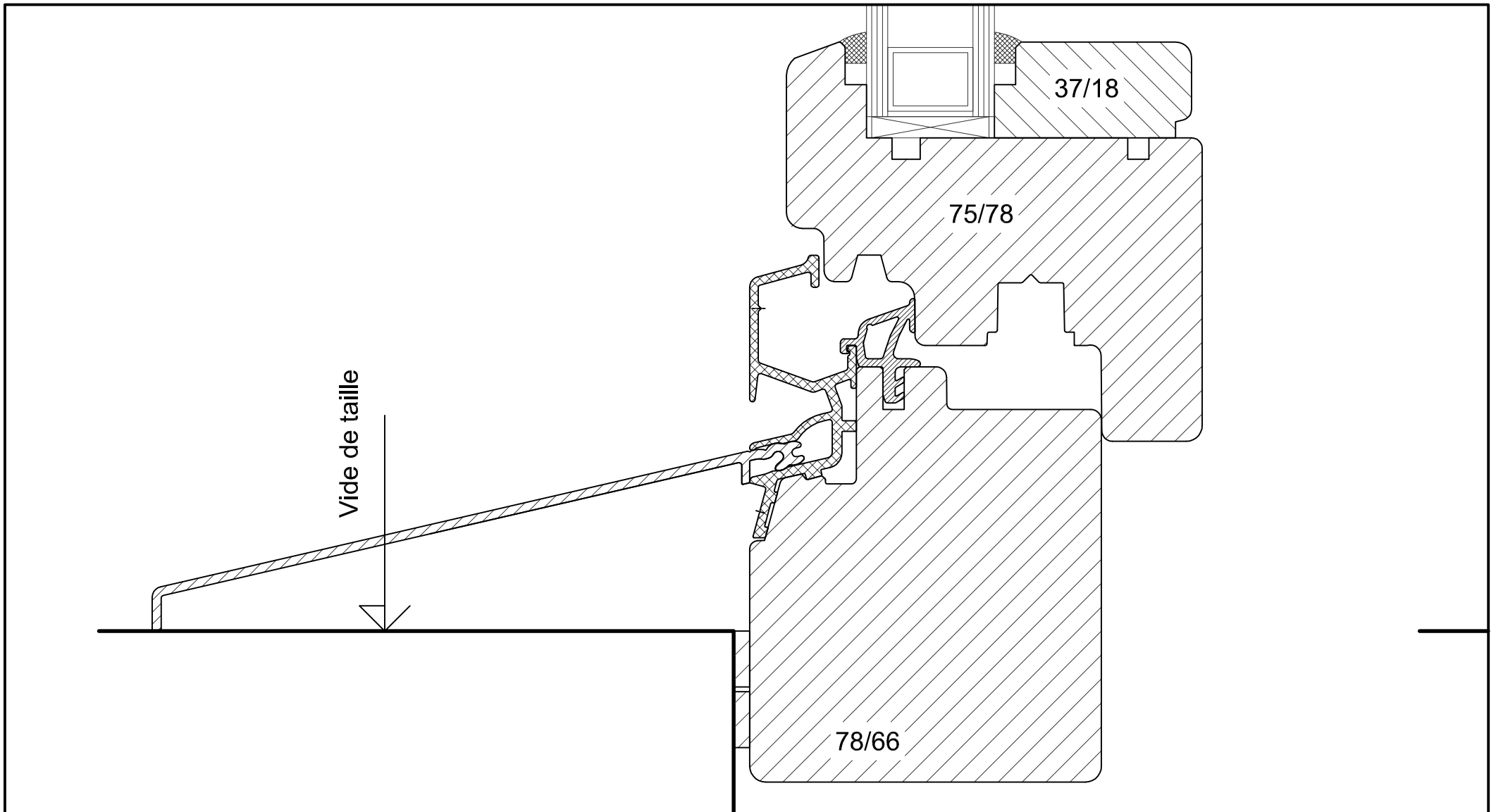

Echelle 1 : 1
Date 17/02/2012
B/66/303



Bois 2012 client.dwg	Echelle 1 : 1
Traverse basse rvd'eau 115mm	Date 17/02/2012
	B/66/303

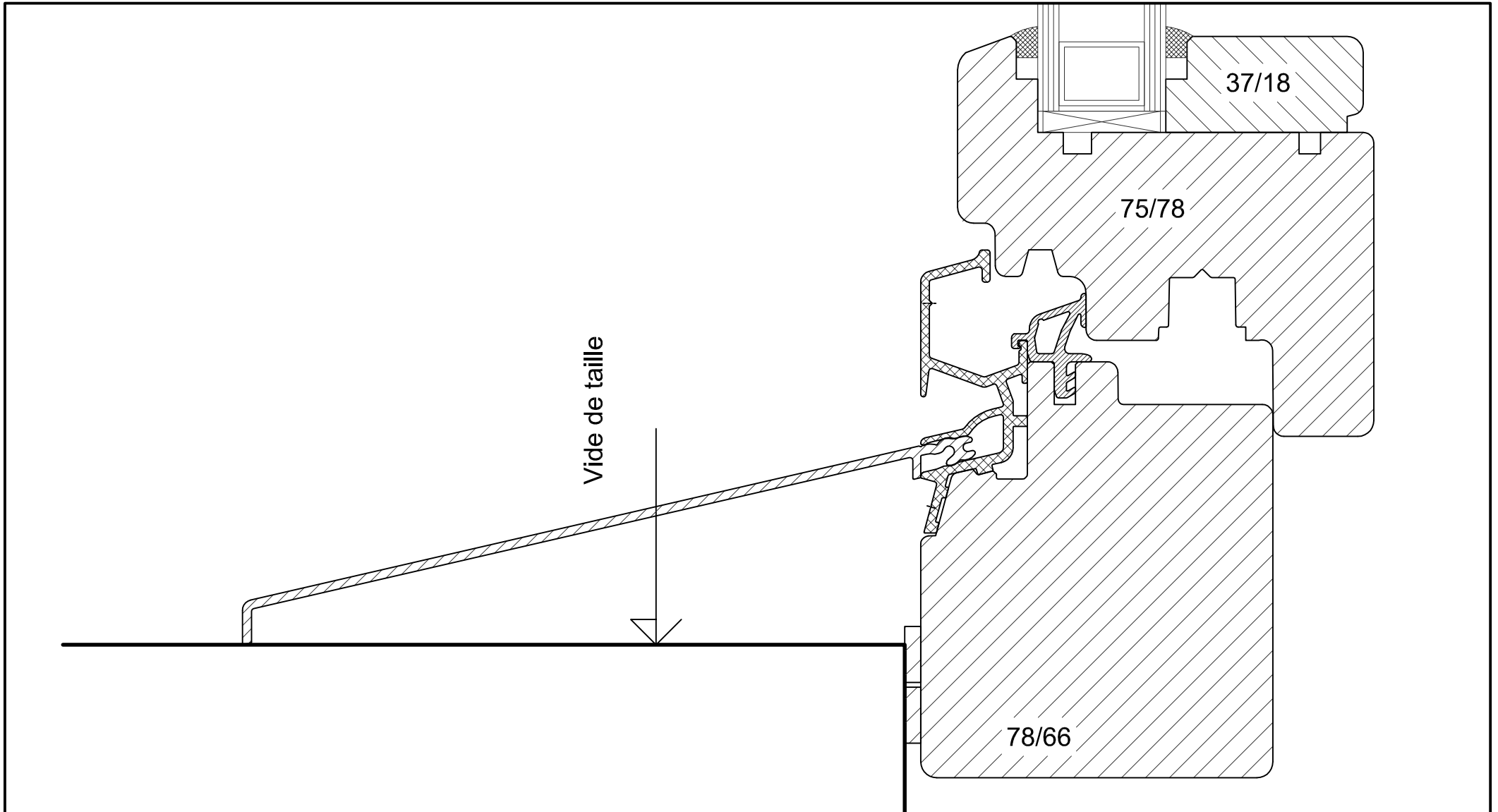

Echelle 1 : 1
Date 17/02/2012
B/66/304



Bois 2012 client.dwg	Echelle 1 : 1
Traverse basse rvd'eau 130mm	Date 17/02/2012
	B/66/304

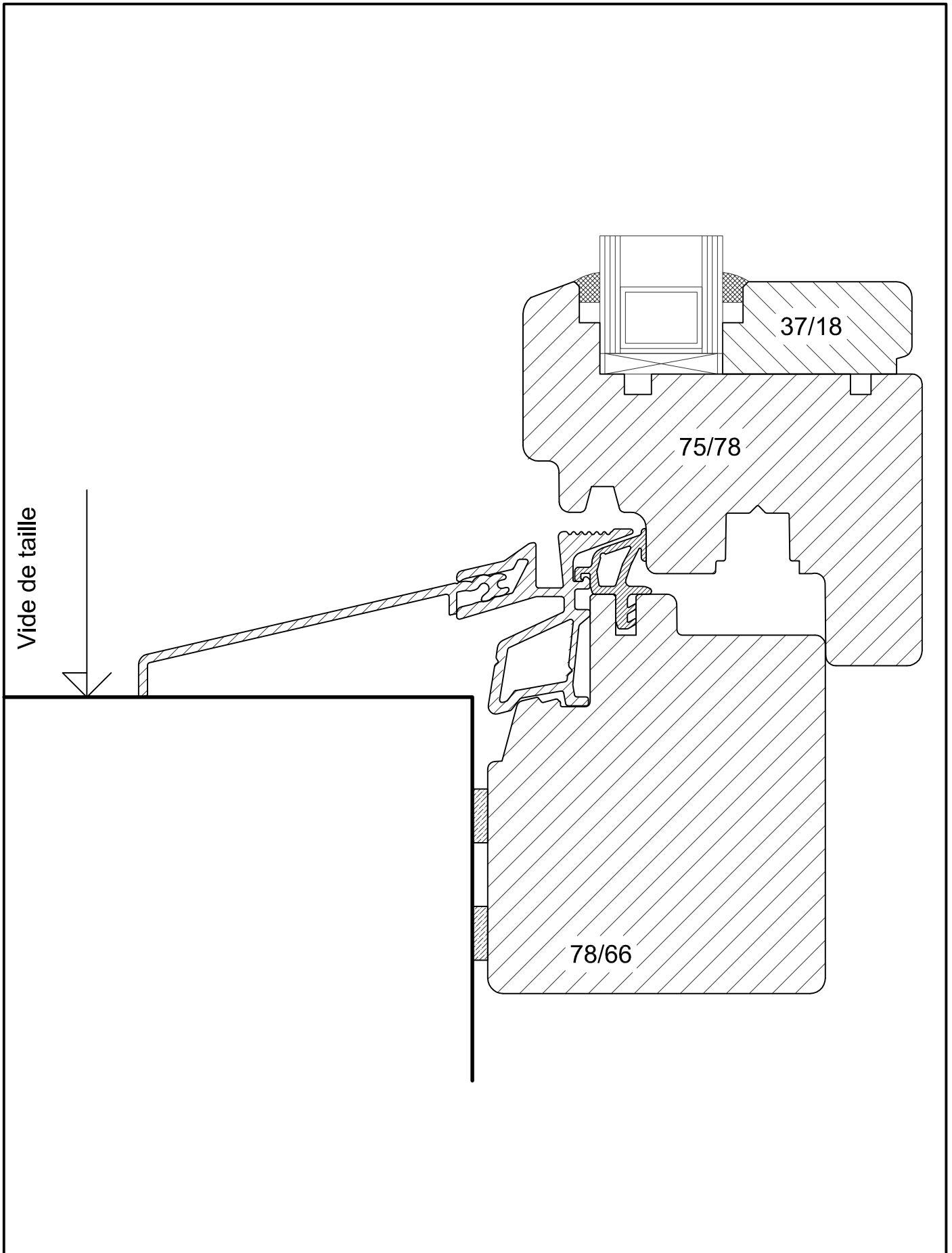

	Bois 2012 client	Echelle 1 : 1
	Traverse basse seuil minimum	Date 17/02/2012
		B/66/305

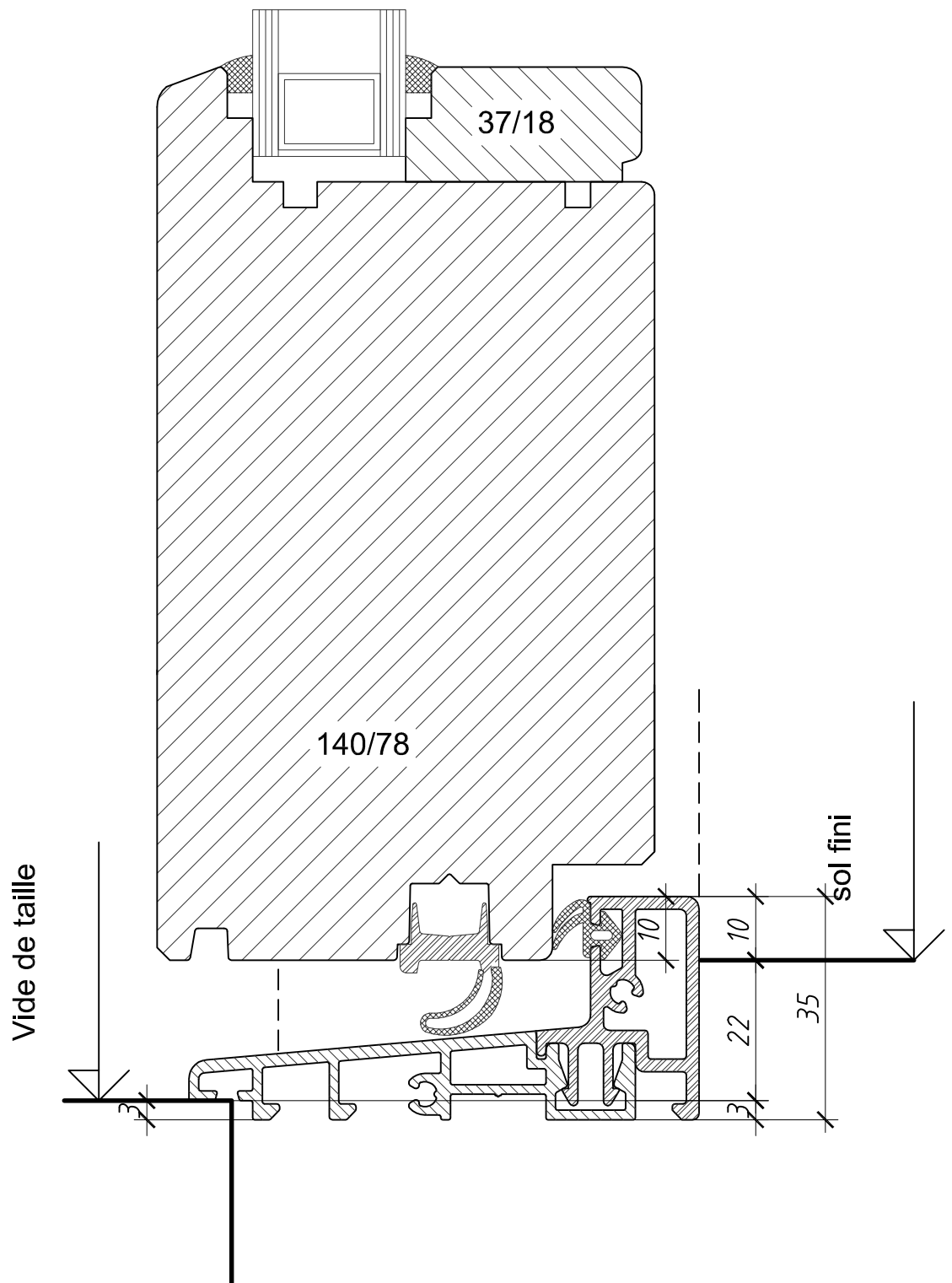

	Bois 2012 client	Echelle 1 : 1
	Traverse basse ouverture sur l'extérieure	Date 17/02/2012
		B/66/306

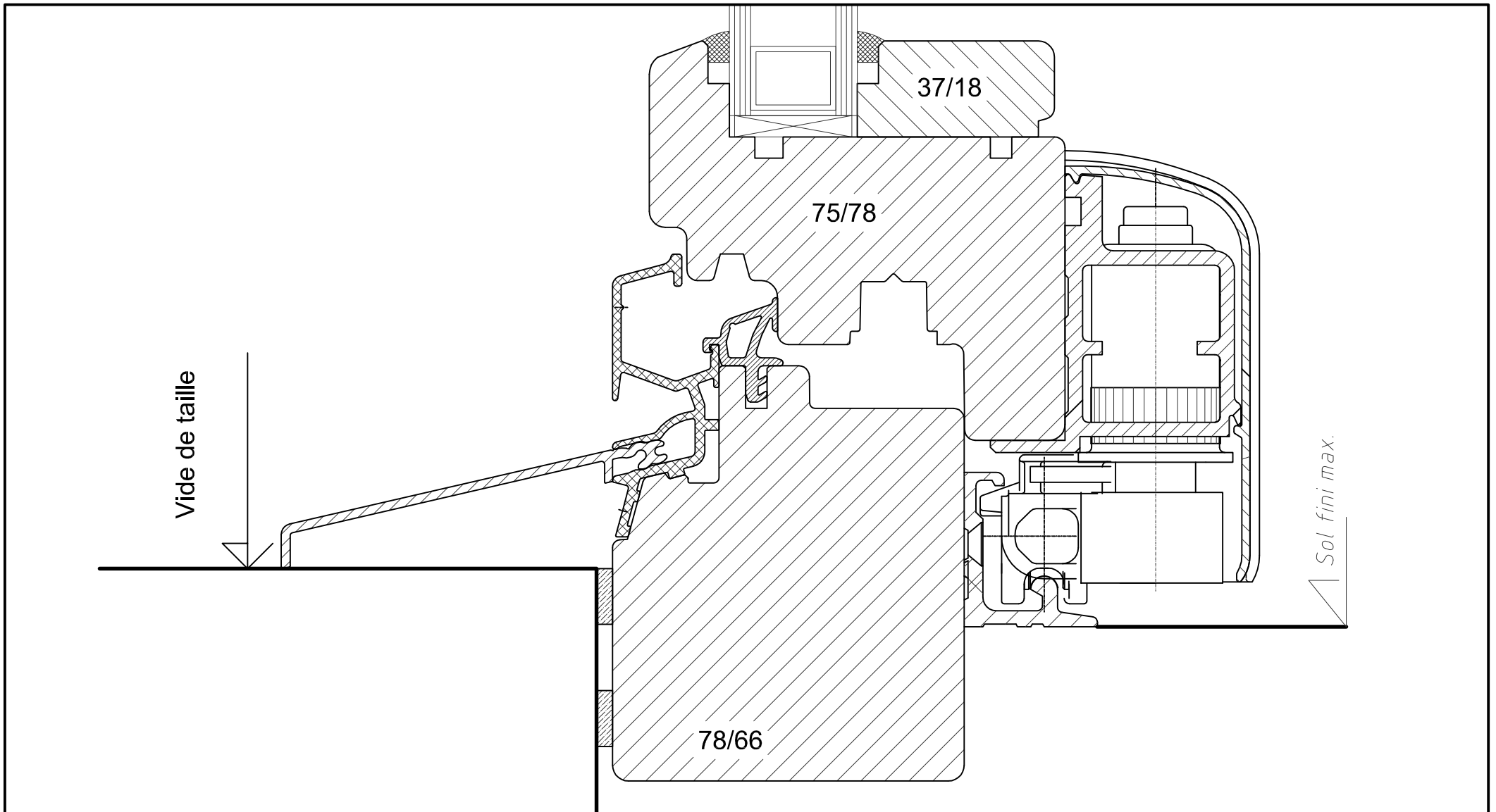

B/66/307	Date 17/02/2012	Echelle 1 : 1
----------	--------------------	------------------



Bois 2012 client.dwg	Echelle 1 : 1
Traverse basse Psk-200Z plus	Date 17/02/2012
	B/66/307

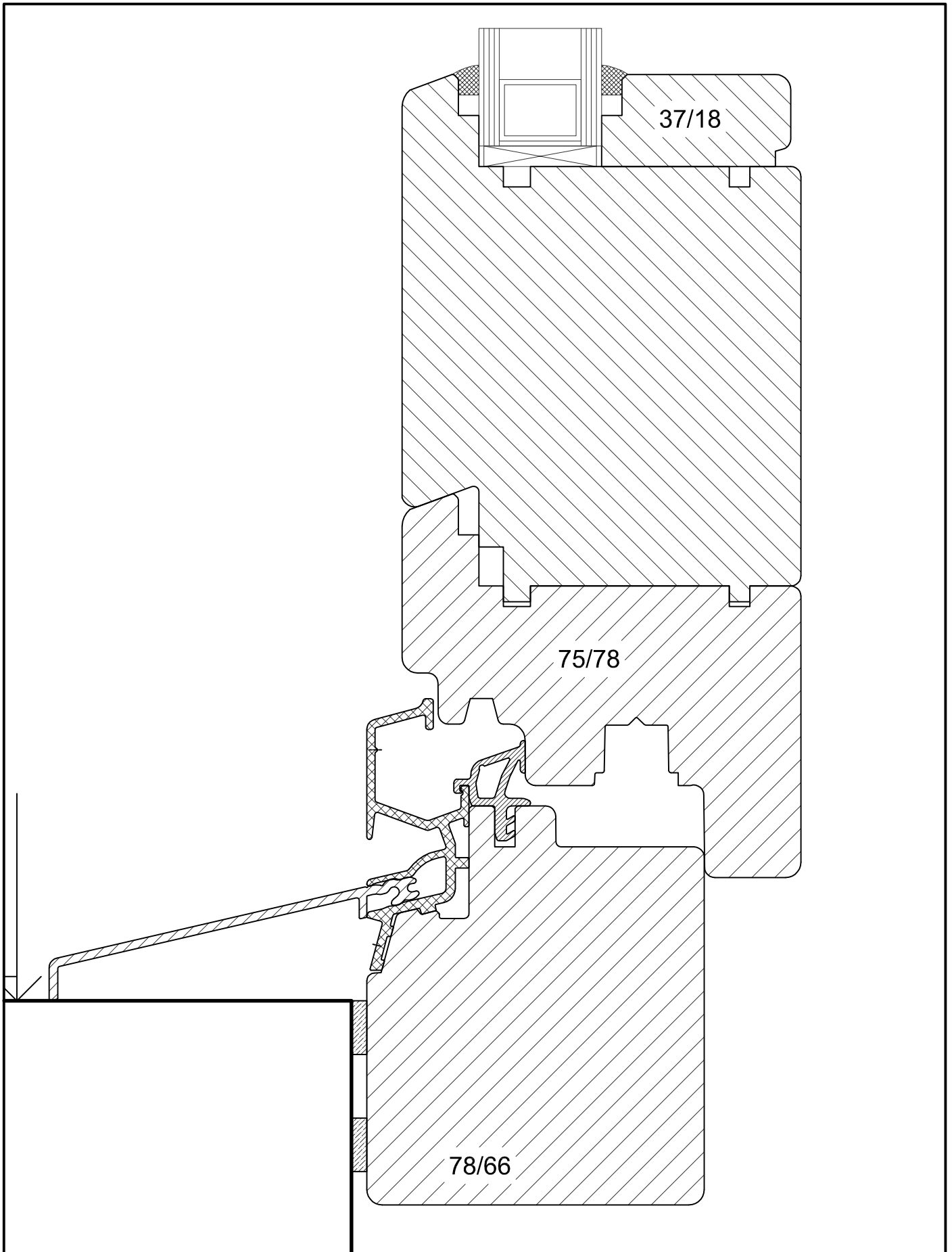

	Bois 2012 client	Echelle 1 : 1
	Traverse basse porte balcon avec remplissage	Date 17/02/2012
		B/66/308

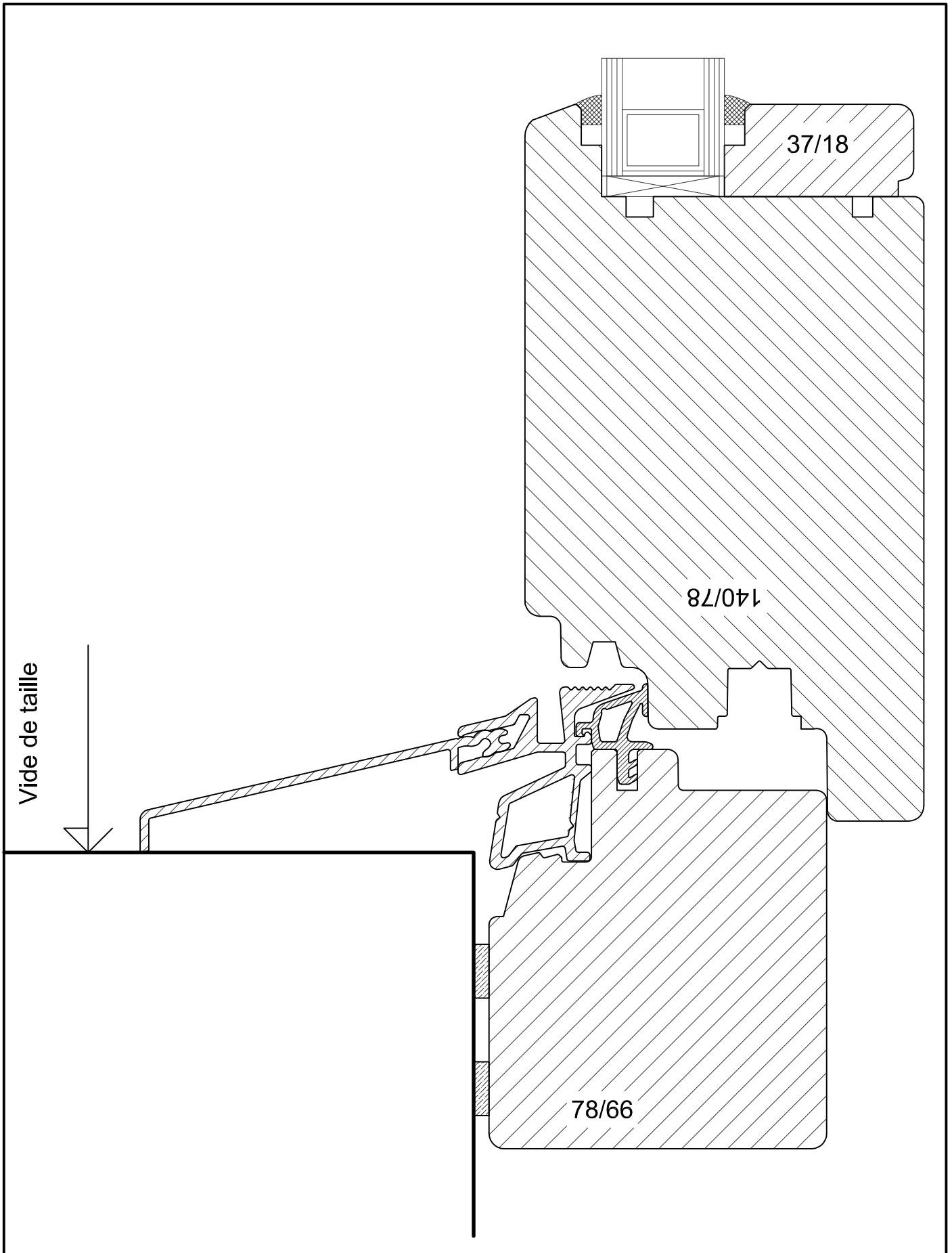

	Bois 2012 client	Echelle 1 : 1
	Traverse basse porte Entrée seuil min	Date 17/02/2012
		B/66/309

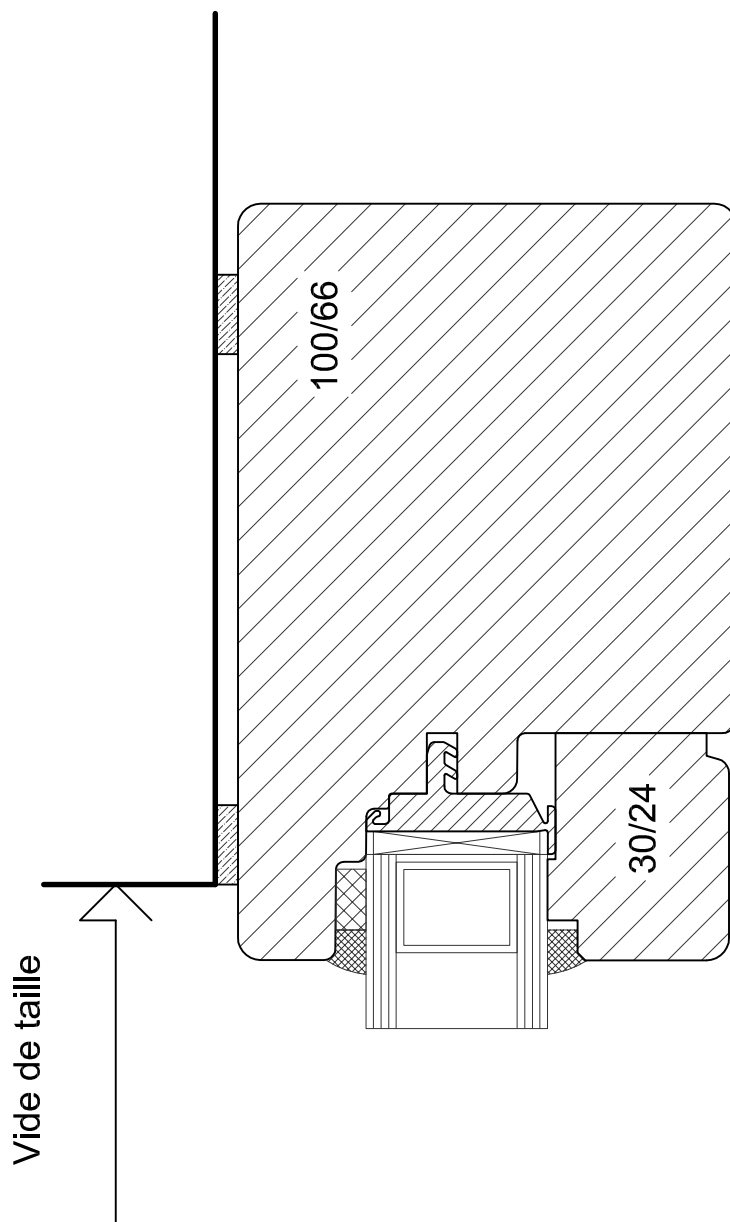

	Bois 2012 client	Echelle 1 : 1
	Traverse haute fixe dans le cadre	Date 17/02/2012
		B/66/400

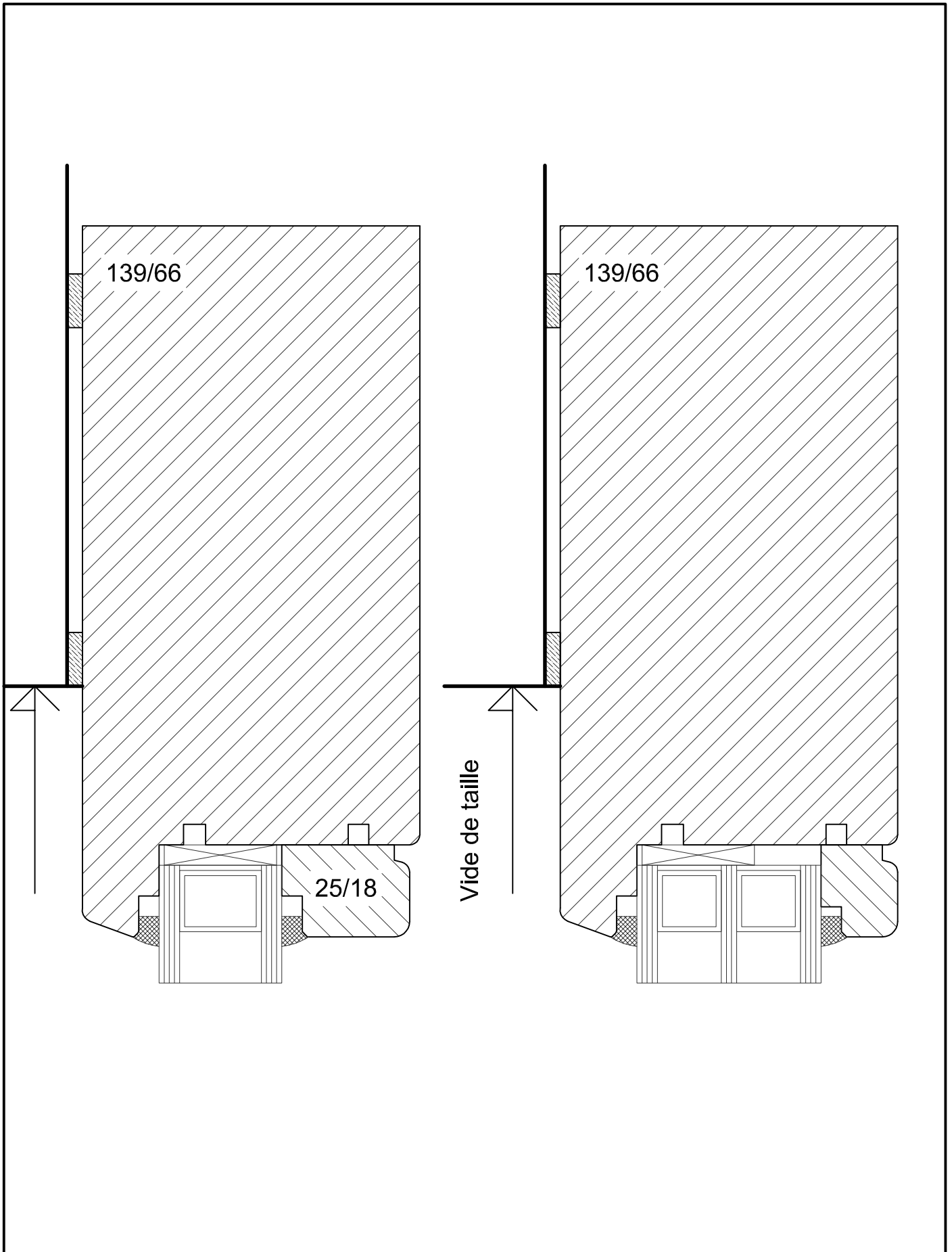

	Bois 2012 client	Echelle 1 : 1
	Traverse haute baie-fixe	Date 17/02/2012
		B/66/401

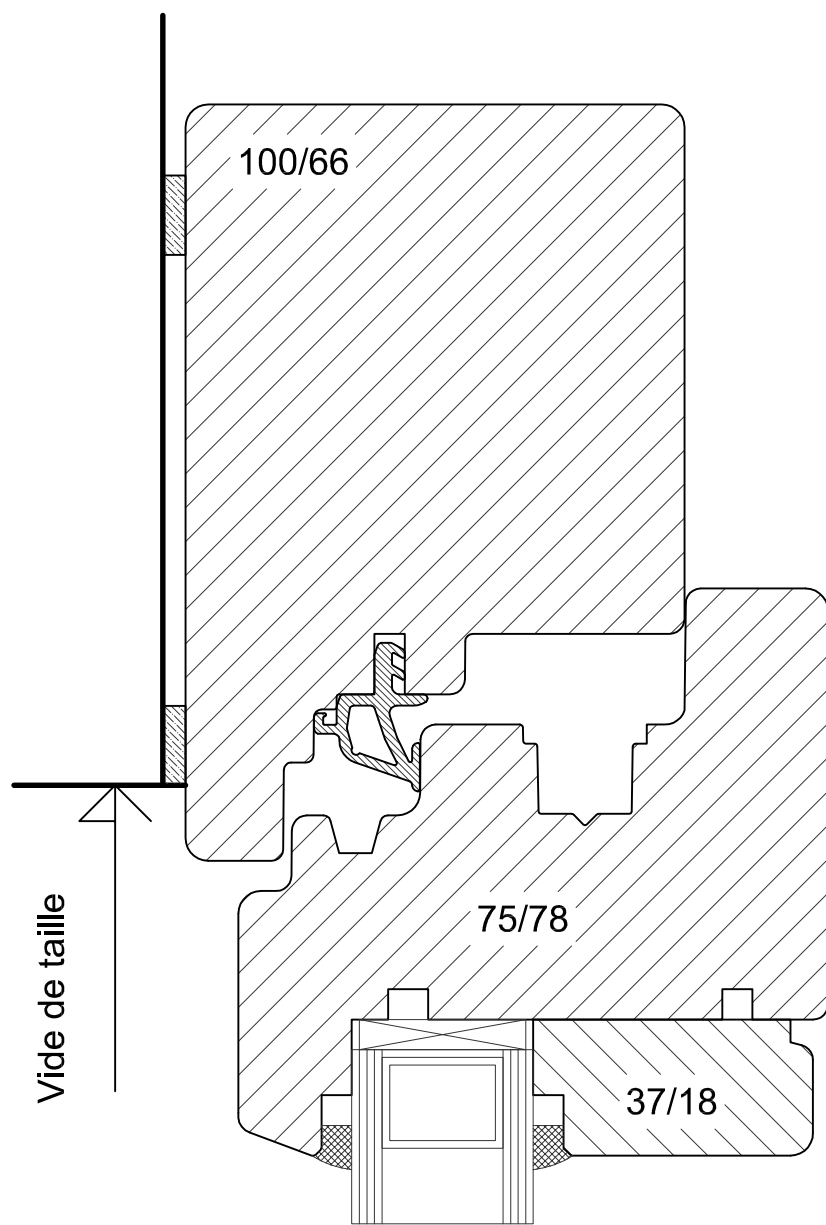

	Bois 2012 client	Echelle 1 : 1
	Traverse haute standard	Date 17/02/2012
		B/66/402

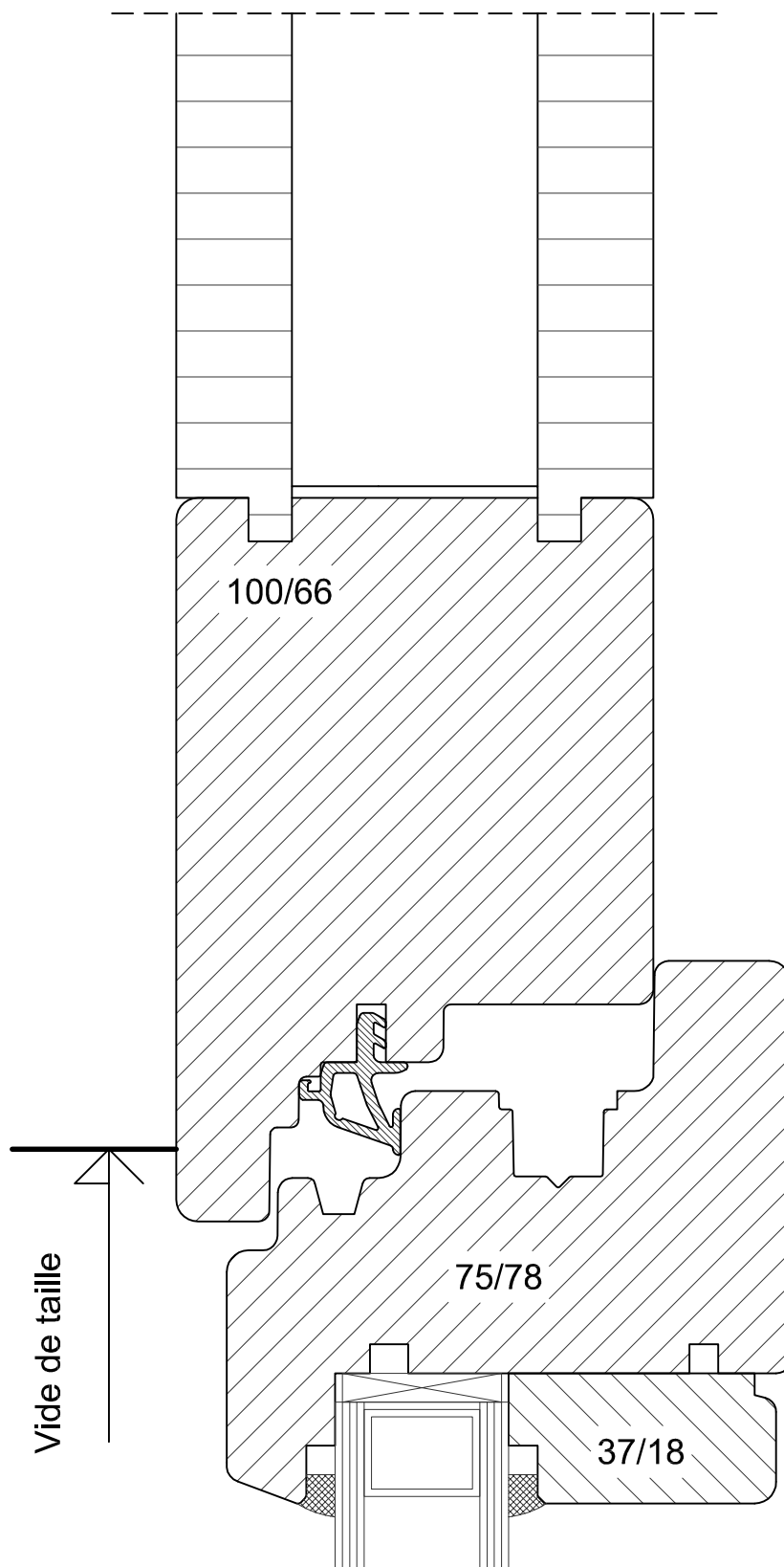

	Bois 2012 client	Echelle 1 : 1
	Traverse haute standard attique	Date 17/02/2012
		B/66/403

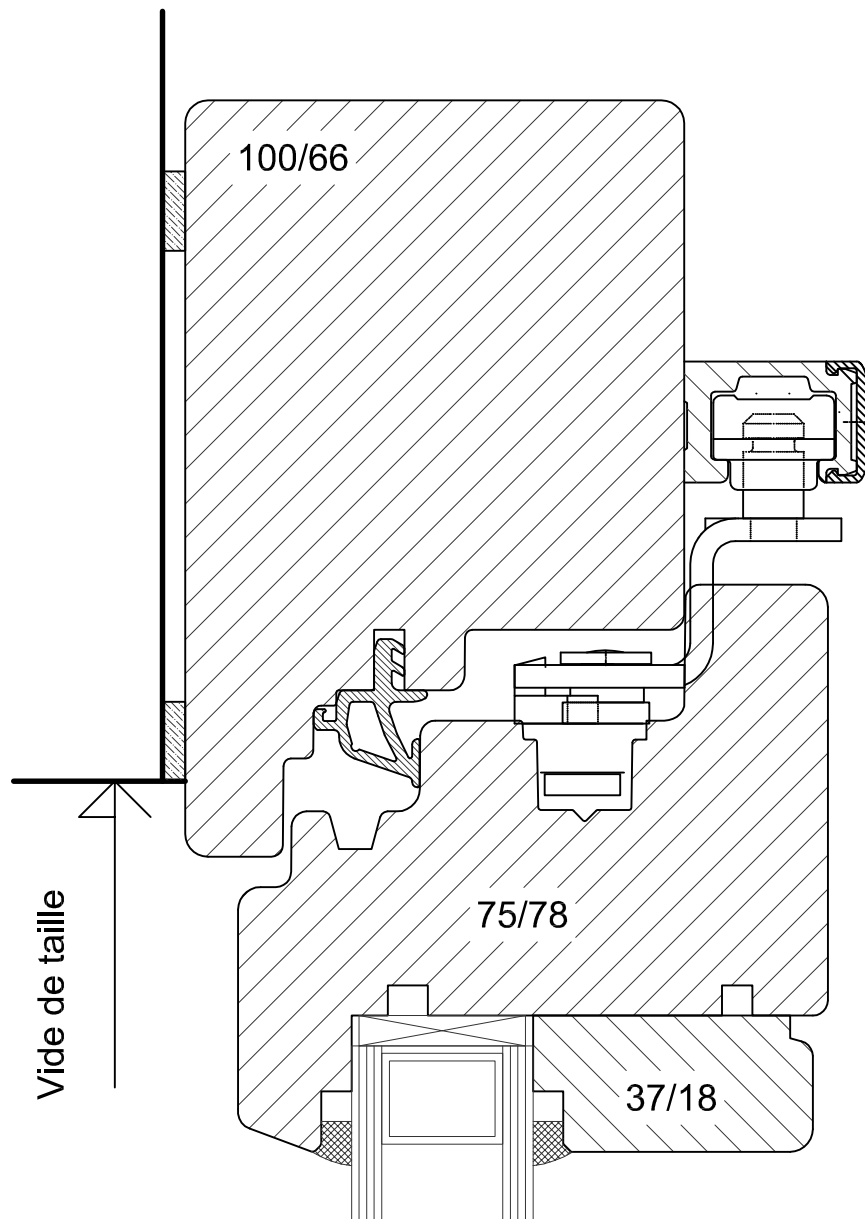

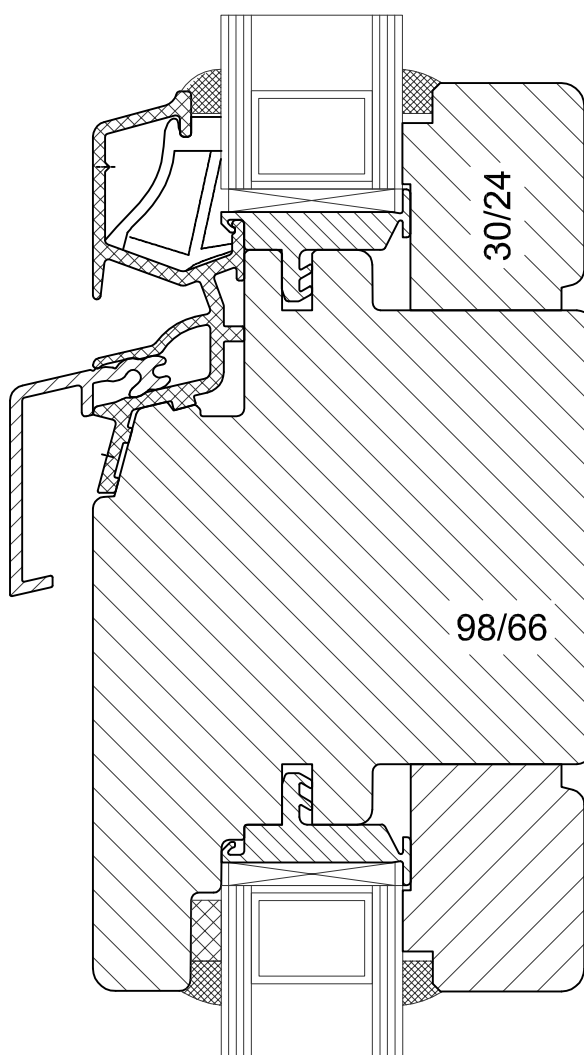

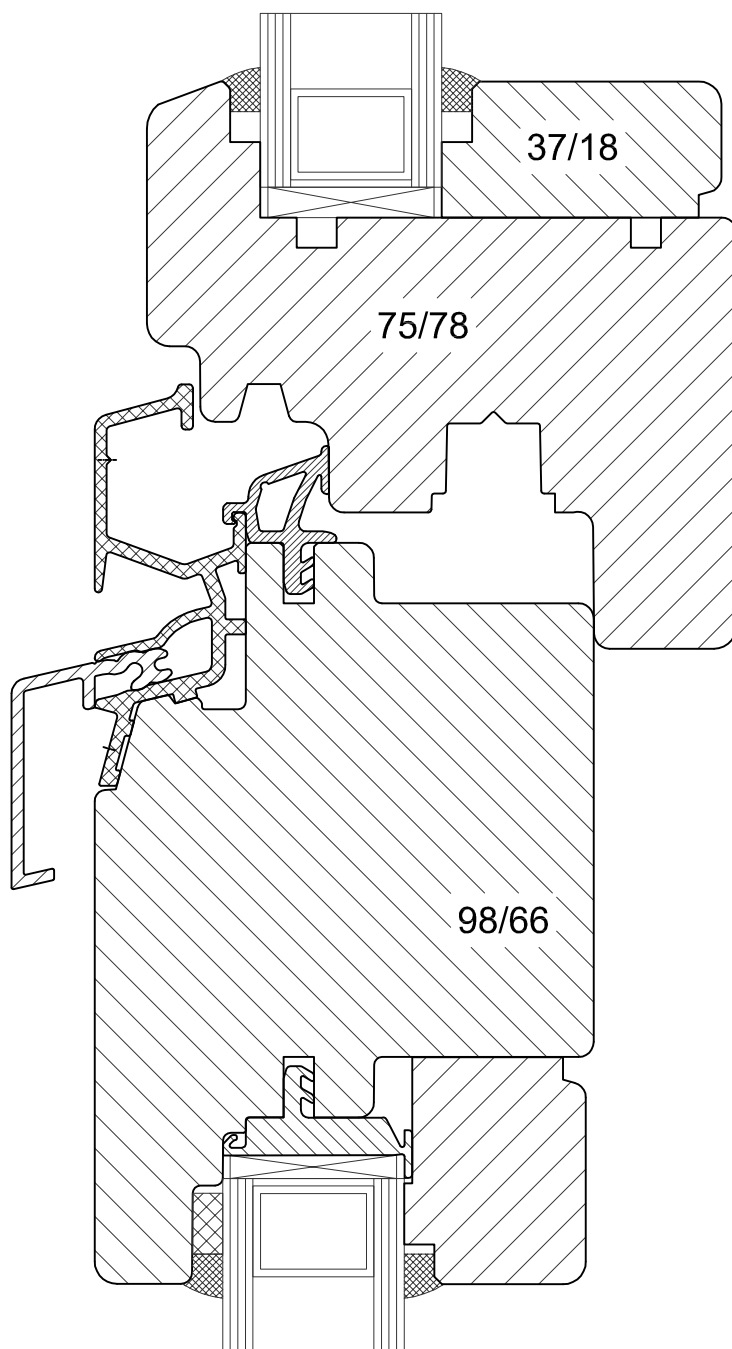

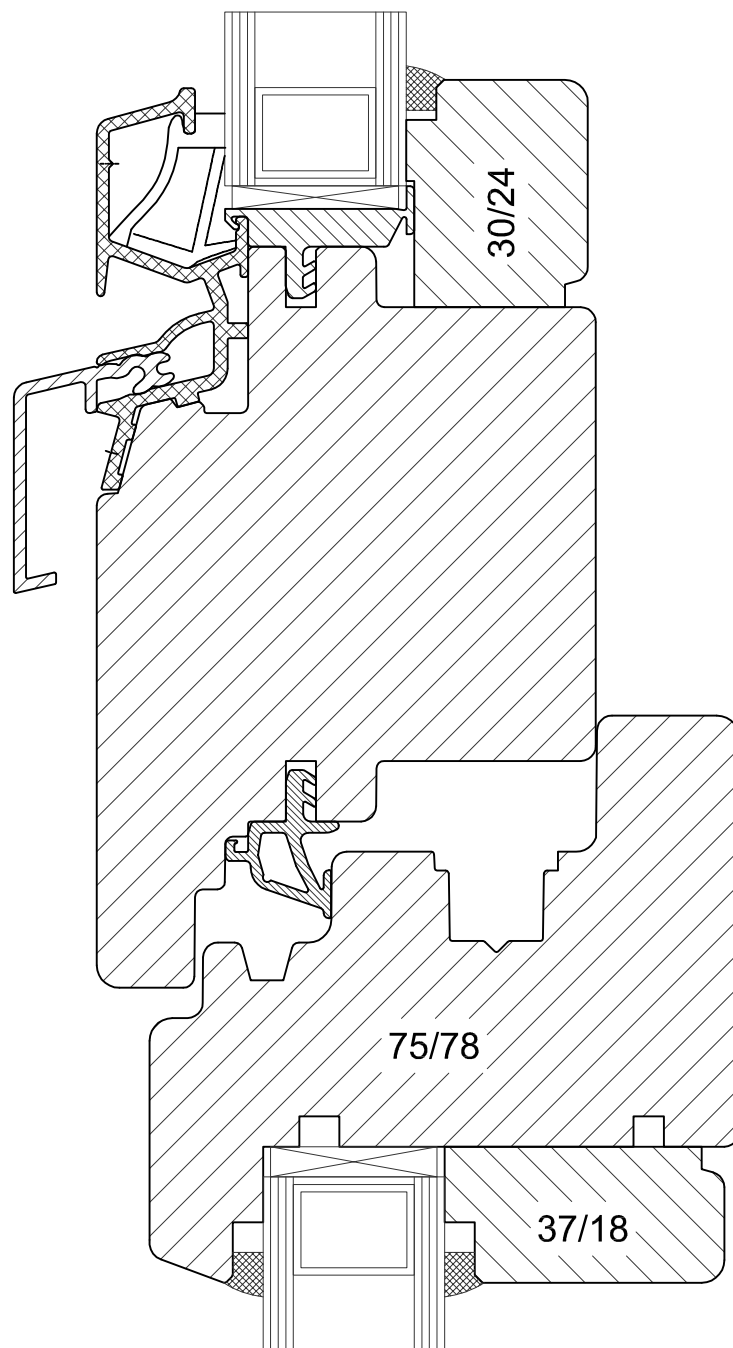

	Bois 2012 client	Echelle 1 : 1
	Traverse int. haut : guichet	Date 17/02/2012
	bas : fixe dans le cadre	B/66/501

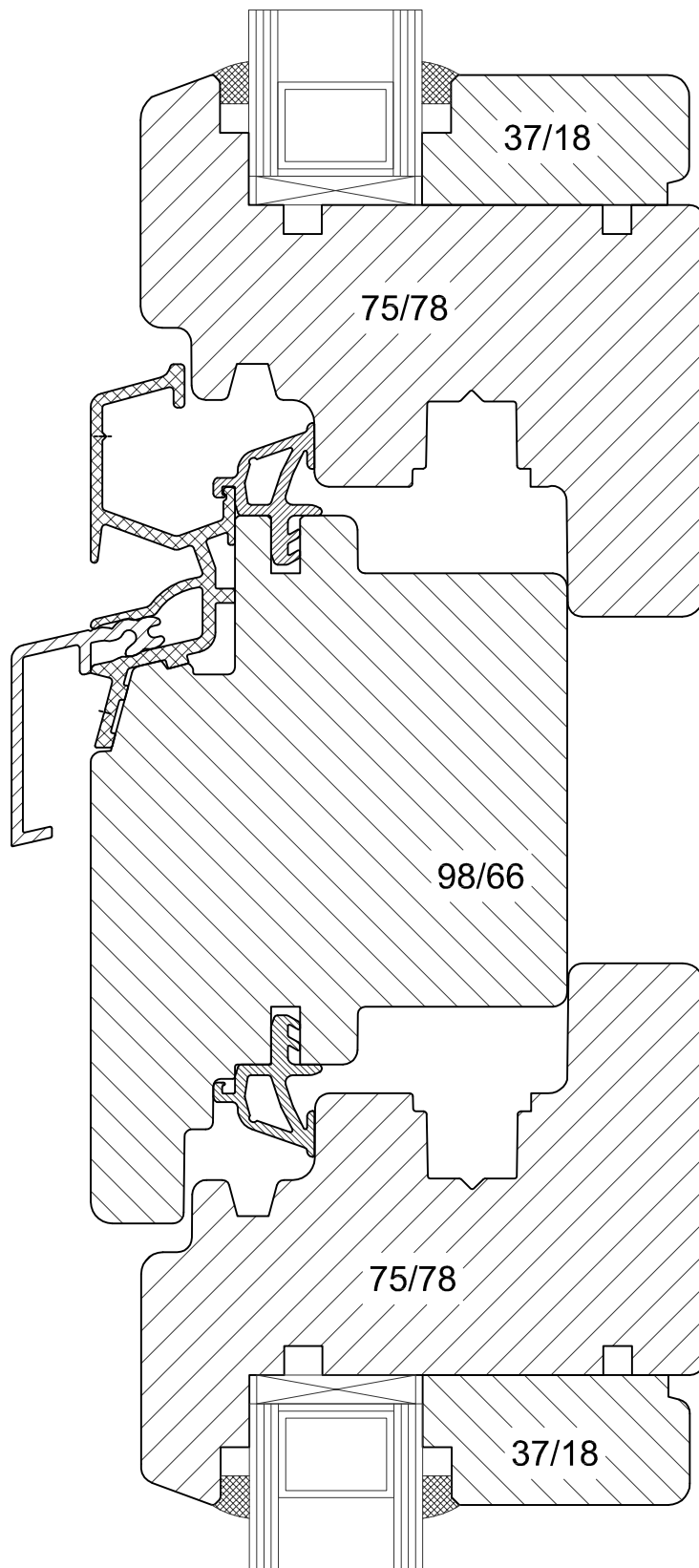

	Bois 2012 client	Echelle 1 : 1
	Traverse int. haut : fixe dans le cadre bas : quichet	Date 17/02/2012
	B/66/502	



	Bois 2012 client	Echelle 1 : 1
	Traverse int. haut : guichet bas : guichet	Date 17/02/2012
		B/66/503

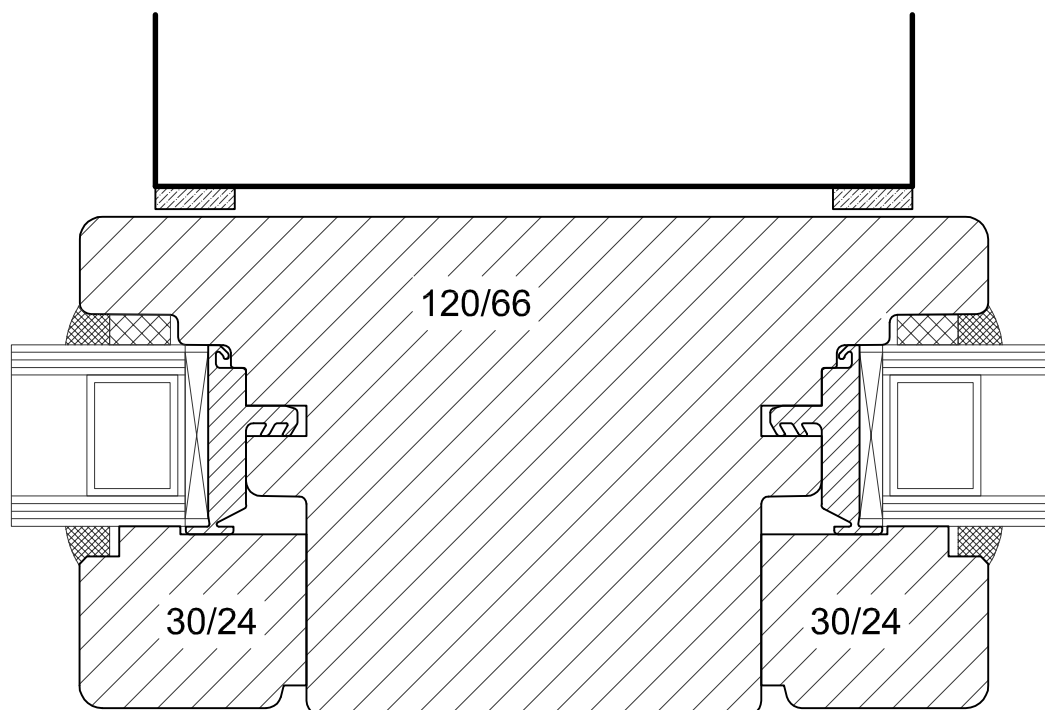

	Bois 2012 client	Echelle 1 : 1
	Montant intermédiaire gauche : fixe dans le cadre	Date 17/02/2012
	droite : fixe dans le cadre	B/66/600

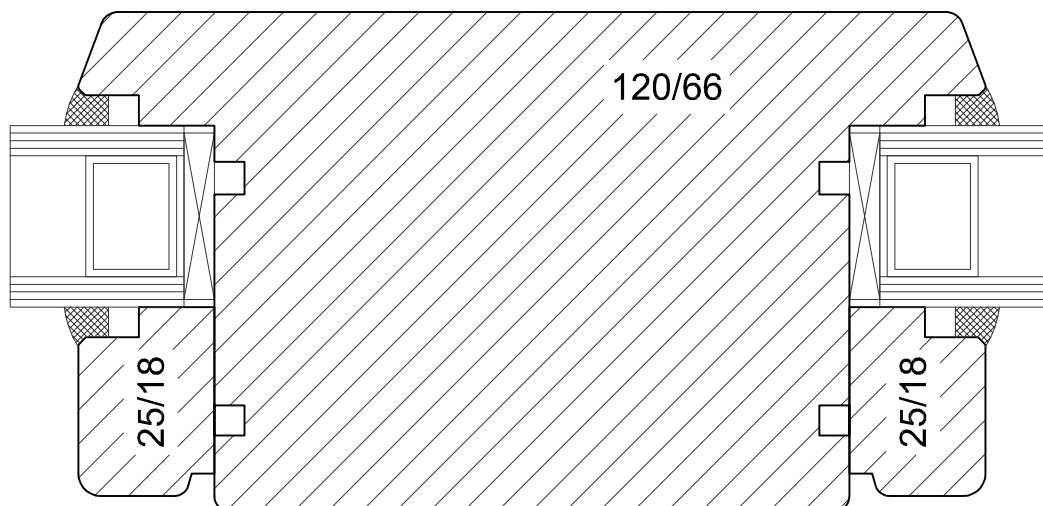

	Bois 2012 client	Echelle 1 : 1
	Montant intermédiaire baie-fixe	Date 17/02/2012
		B/66/601

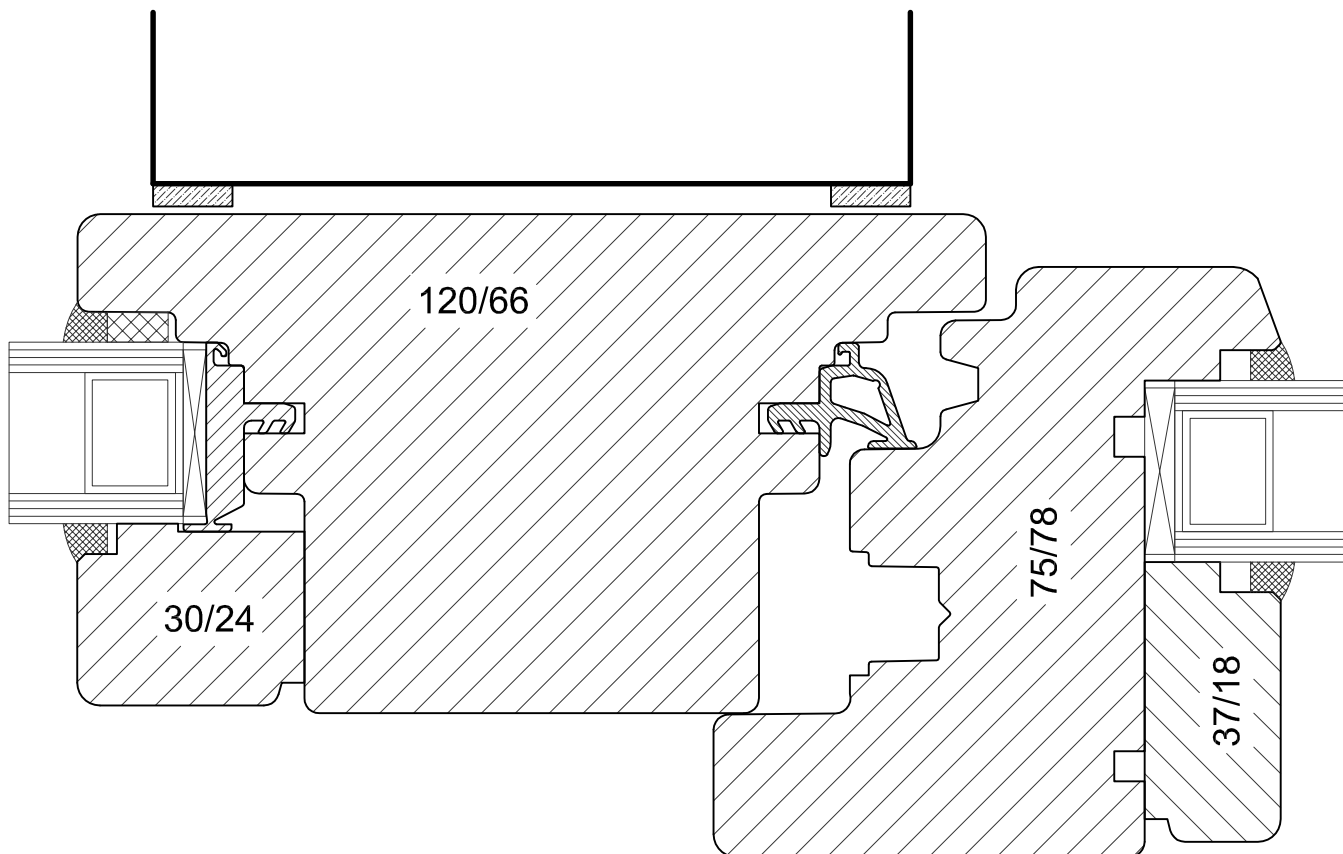

	Bois 2012 client	Echelle 1 : 1
	Montant intermédiaire gauche : fixe dans le cadre droite : guichet ouvrant	Date 17/02/2012
	B/66/602	

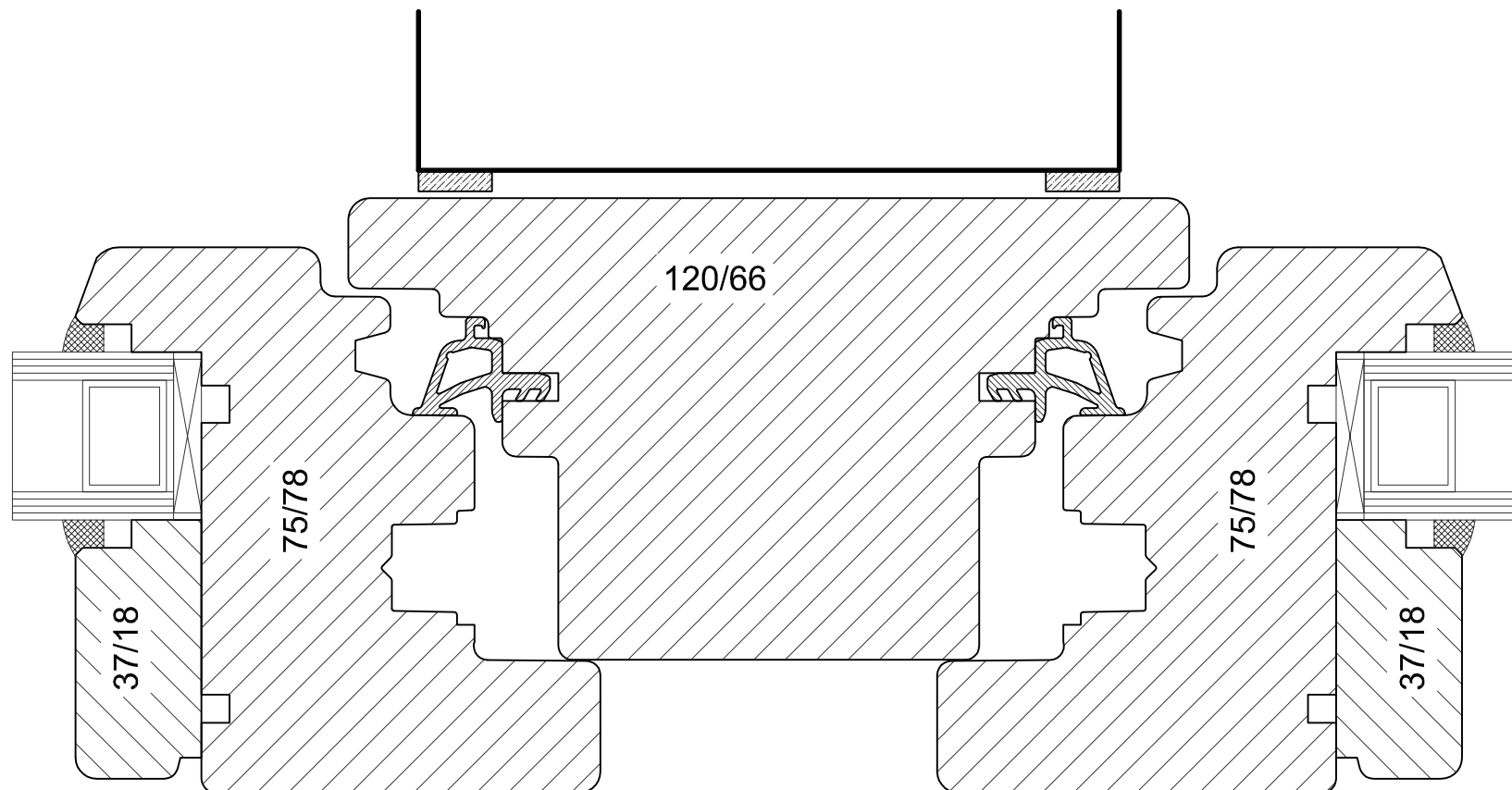

B/66/603	Date 17/02/2012	Echelle 1 : 1
----------	--------------------	------------------



Bois 2012 client.dwg	Echelle 1 : 1
Montants intermédiaire gauche: guichet ouvrant droite : guichet ouvrant	Date 17/02/2012
	B/66/603